



# **RODCRAFT®**

[www.rodcraft.com](http://www.rodcraft.com)

## ***Pneumatic Tools***



***Quality  
Technology  
Service***

For over 35 years, RODCRAFT stands for high quality, value-added products and services. Founded at Mülheim an der Ruhr, Germany, RODCRAFT has grown steadily to become one of the world's leading suppliers of pneumatic tools and equipment in the market segments concerned. Our active engagement in the market and the quality of

our products, has earned us a brand recognition level of over 86% in our major markets. Continuously improving our products, services and processes, our product company and many customer centers are ISO 9001 and ISO 14001 certified. We are constantly investing in our capabilities, in order to match our customers future demands.

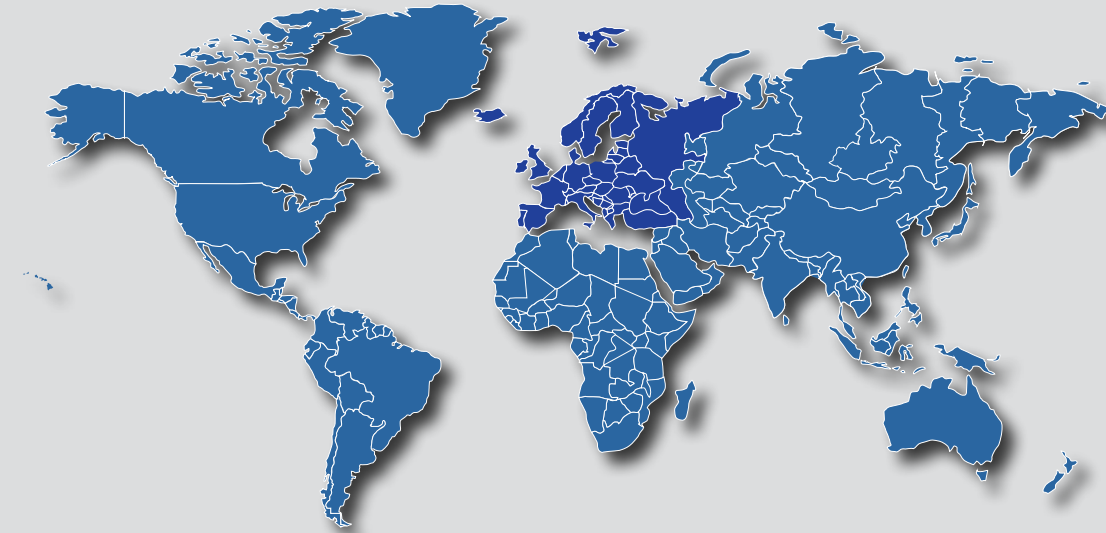

## Distribution

Our customer centers and warehouse facilities are covering with our distributors over 80 countries worldwide on a daily basis. So we are close to our customers and can give a fast service and support.

## Training Facilities and Trade Shows



Customer training and seminars are regularly held by our skilled staff in Germany and at our customer centers.

## 3D-CAD Design

For many years, RODCRAFT's use of computer aided 3 dimensional design (3D-CAD), has greatly shortened product development cycles and improves the communication with manufacturing. Many of our products feature patented designs, exclusive to RODCRAFT, such as our new composite sander and impact wrench series. Our trained technicians are able to quickly implement new market-driven ideas, into full-scale production models for modern high performance and ergonomic tools.

## Testing Capabilities

Our state of the art testing equipment, located at our headoffices and in the service centres, is an integral part of our leadership strategy, supplying safe, high quality and performance products to our customers.



RODCRAFT's international and regional trade show presence.

<b>RODCRAFT</b>	<b>page</b>	<b>2</b>
<b>Content</b>	<b>page</b>	<b>3</b>
<b>Model Number Index</b>	<b>page</b>	<b>69</b>
Impact Wrenches (with impact mechanism overview)	page	4 - 12
Battery Impact Wrenches	page	12
Tyre Fillers, Certified and Digital	page	12
Safety Gloves	page	13
Ratchet Wrenches	page	14 - 16
Drills	page	17 - 18
Screwdrivers	page	19
Hammers, Engraving Pen, Scrapers	page	20 - 22
Needle Scalars	page	23
Staplers and Nailers	page	24
Sheet Metal Tools	page	25
Saws	page	26
Spot Weld Drills, Punching/Welting Tool	page	27
Riveters	page	28 - 29
Auto Glass Removal Tools, Cutters, Blades	page	30 - 31
Die Grinders, Tyre Buffers and Sticker Erasers	page	32 - 34
RODCRAFT MBX - Removal System	page	36 - 37
Belt Sanders	page	35
Angle Sanders and Pistol Sanders	page	39
Angle Grinders	page	40 - 41
Polishers	page	41
Orbital Sander Selection Table	page	43
Spot Repair Sanders	page	44
Random Orbital Sanders	page	45 - 46
Dust Extraction Stations, Accessory	page	47
Orbital Sanders, Linear Sanders	page	48
Sand Blasters	page	48
Paint Guns	page	50
Cartridge Guns, Sachet (Sausage) Guns and Seam Sealing Guns	page	51
Underbody Coating Guns and Cleaning Guns	page	52
Blow Guns and Suction Guns (Pneumatic Vacuum Cleaner), Pocket Blow Pens	page	52 - 53
Grease Guns	page	54
Accessories	page	55 - 68
Sockets	page	55 - 56
Chisels and Other Hammer Accessories	page	57
Staples, Brads and Nails (Strips)	page	58
Small Part Storage, Magnetic Dishes	page	58
Saw Blades and Files	page	59
Sanding Belts, Collets and Roloc Accessories	page	60
Sanding Pads and Polishing Accessories	page	61 - 62
Balancers and Hose Balancers	page	63
Air Line Installation and Maintenance	page	64
Maintenance Units, Filters, Water Separators, Regulators, Lubricators, Lubricants	page	65
Couplings, Plugs and Fittings	page	66
Hoses, Hose Reels and Exhaust Hose Silencer Kits	page	67
Grease Pumps	page	68
Addresses Sales / Service	page	70 - 71

## Single Hammer "SH"

Long proven, inexpensive construction with one (two) hammer(s) and grease lubrication.

**For all standard assembly work in:**

- hardware and agro-mechanics
- light industrial sector
- automotive repair services
- tyre services
- can be found in model: RC2100, RC2111, RC2425 and their variants

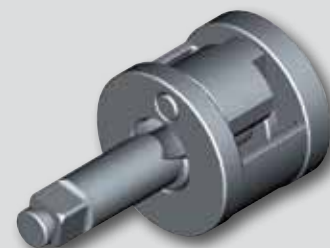

## Pin Clutch "PC"

Low vibration impact system with rapid torque increase and economic construction consisting of hardened, turned parts running in a closed impact cage. Lubricated with impact system oil model 1000S (oil bath lubrication - except model 2530 mechanism lubricated with grease)

**For all quick assembly work in :**

- tyre services
- automotive repair services
- hardware
- light industrial sector
- can be found in model: RC2205, RC2227, RC2345, RC2530 and their variants



## DUOPACT "DP"

Reliable system for continuous torque increase with two extremely robust, forged ring-hammers. Consisting of surprisingly few parts and having an extremely short design. Lubricated with grease - lubrication from outside partly possible with our Mini Grease Pump models 8150, 8160 without opening the housing.

**For all extremely intense applications, like :**

- industry
- tyre services
- automotive repair services
- can be found in model: RC2257, RC2277, RC2350, RC2477Xi, RC2485, RC2490, RC2585 and their variants



## SmartDUOPACT "SmartDP"

New generation of the reliable DUOPACT system but building up torque much faster, this reduces assembly times and increases work efficiency. With integrated ball bearing and lubricated by grease.

**For all fast and intense applications like :**

- assembly
- tyre services
- automotive repair services
- can be found in model: RC2263Xi, RC2363Xi, RC2403Xi, RC2433Xi, RC2484Xi and their variants

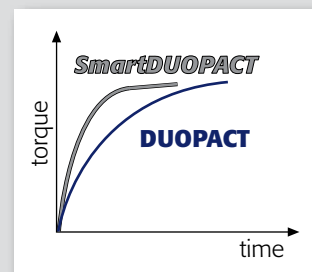

## Closed Hammer System "CH"

This almost maintenance-free running mechanism is dedicated to break loose nuts and bolts without large effort due to its massive closed inertia. The construction is showing a very good weight / power ratio and has typically a short design. The closed construction means that once lubricated, the grease filling stays in place at the hammer for long period of time.

**typical for:**

- industry
- truck and bus tyre services and assemblies
- can be found in model: RC2439, RC2444, RC2476 and their variants



**Please also try our special mechanisms**

**"TL-Torque Limited" for fast and safe pre-tightening for precise final torquing by torque wrench, e.g. tyre services**

- can be found in model: 2263TL

**TORQUE LIMITED "TL"**





### Impact Socket Sets 3/8"

13 piece set with impact proof sockets made of high steel grade (CrMo). Delivered in a tool case, with individual socket moulds marked with each size. All sockets are laser etched showing the model no. and size. Set includes socket sizes:  
7/8/9/10/11/12/13/14/15/16/17/18/19 mm

Set, short	Model	Article no.
	<b>RS3113</b>	8951012354
Set, long	<b>RS3113D</b>	8951012355

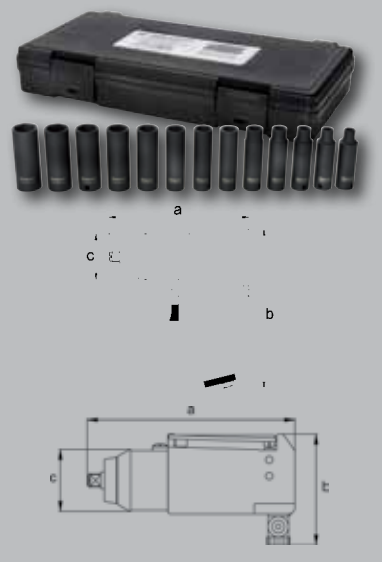

3/8" impact wrench for small bolts. Regulation of the impacting power in both directions possible.

<b>impact wrench 3/8"</b>	Model	Article no.
	<b>RC2111</b>	8951077020

**150 Nm max.**



**150 Nm max.**

3/8" Impact Wrench for confined areas (motorcycles). Butterfly valve for F/R shifting with one hand. Integrated power regulation valve with 8 positions and 360° swiveling air inlet.

<b>impact wrench 3/8"</b>	Model	Article no.
	<b>RC2100</b>	8951077010



**580 Nm max.  
composite  
only 1.25 kg**



Very handy 3/8" impact wrench. High quality composite motor housing with TPR (thermo-plastic rubber) grip areas on the handle for good tool control. With 3 position power regulator (in forward) and surprisingly low noise and low air consumption motor.

<b>Impact Wrench 3/8"</b>	Model	Article no.
	<b>RC2177</b>	8951000043



Model	Drive	Torque		Speed	Weight	Inner hose diameter	Dimension a x b x c	Air Consumption average - continuous		Air inlet	Impact system	Noise LpA	Vibration
	[inch]	[Nm]		[min <sup>-1</sup> ]	[kg]	[mm]	[mm]	[l/min]		[inch]		[dB(A)]	[m/s <sup>2</sup> ]
RC2100	3/8"	105	150	10000	1.1	8	165x87x48	140	370	1/4" IG	SH	97.1	4.57
RC2111	3/8"	105	150	10000	1.3	8	135x165x47	150	410	1/4" IG	SH	92.7	3.75
RC2177	3/8"	420	580	8200	1.25	8	164x175x60	160	470	1/4" IG	DP	90	7.9

max. pressure 6.3 bar (90 psi) FT: female thread norms applied : noise according to ISO15744, vibration 3-axis according to ISO28927-2, more detailed specs see page 69.

# 1/2" Impact Wrenches

164 mm

**660 Nm max.  
composite only  
1.25 kg**



Mini 1/2" impact wrench with high power, but low weight. High quality composite motor housing with TPR (thermo-plastic rubber) grip areas on the handle for good tool control.

With 3 position power regulator (in forward) and fast air motor for quick assemblies and disassemblies also in confined areas.

Mini-Impact Wrench 1/2" Model **RC2267** Article no. **8951000044**

**580 Nm max.**



Favoured standard tool, easy to switch with one hand. With 4 position torque regulator (in forward).

Variant with a silencing exhaust hose Model **RC2205RE** Article no. **8951077350**  
without hose Model **RC2205** Article no. **8951077060**

**950 Nm max.  
only 2.6 kg  
pin-clutch**



Versatile tool with low vibration and low air consumption, equipped with a fast pin-clutch mechanism. With power regulator in forward and reverse. For fast and safe

work the tool can be operated by one hand only. Difficult to reach bolts and nuts can be easily reached due to the slim front of the wrench. Equipped with an adapter to attach a silencing exhaust hose system.

Impact wrench 1/2" with pin-clutch mechanism Model **RC2227** Article no. **8951000036**

**950 Nm max.  
only 2.5 kg  
DUOPACT**



Robust and very compact universal tool with forged DUOPACT impact mechanism for every workshop. With power regulator in forward and reverse. For fast and safe work

the tool can be operated by one hand only. Equipped with an adapter to attach a silencing exhaust hose system.

Impact wrench 1/2" with DUOPACT mechanism Model **RC2257** Article no. **8951000037**

## Impact Socket Sets 1/2"

14 piece set with impact proof sockets made of high steel grade (CrMo). Delivered in a tool case, with individual socket moulds marked with each size. All sockets are laser etched showing the model no. and size. Set includes socket sizes: 10, 11, 12, 13, 14, 15, 16, 17, 18, 19, 21, 22, 26, 27 mm

Set, short Model **RS4114** Article no. **8951012356**  
Set, long Model **RS4114D** Article no. **8951012357**



short and long sockets and other 1/2" accessories you will find on page 55

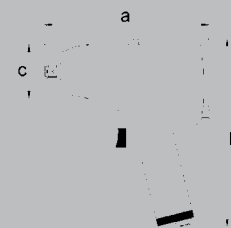

Model	Drive [inch]	Torque		Speed [min <sup>-1</sup> ]	Weight [kg]	Inner hose diameter [mm]	Dimension a x b x c [mm]	Air Consumption average - continuous [l/min]		Air inlet [inch]	Impact system	Noise LpA [dB(A)]	Vibration [m/s <sup>2</sup> ]
		M	Mmax										
RC2205RE	1/2"	406	580	7800	2.4	8	200x210x60	130	350	1/4" IG	PC	87.4	6.71
RC2227	1/2"	680	950	8700	2.6	8	200x194x70	190	570	1/4" IG	PC	95	5.1
RC2257	1/2"	680	950	8950	2.5	8	213x194x70	200	610	1/4" IG	DP	94	6.8
RC2267	1/2"	480	660	10200	1.25	8	164x175x60	180	510	1/4" IG	DP	93	6.9



### Power reduction

In order to prevent overtightening of threaded connections this reduction serves to pretighten nuts and bolts carefully e.g. before using a torque wrench for final torquing. The power reducer and the forward / reverse shift are practically integrated in one knob, sunk into back of tool and made of metal well protected and sturdy against shocks. The F/R shift is large and easy to grab for professional use and is designed to deliver always full power in reverse.

# THE BEAST

1250 Nm max.



1/2" Composite impact wrench for universal use. Fast and high torque with forged DUOPACT mechanism. Lightweight even at this high power - only 2.0 kg. Robust forward-reverse shift/power regulator on one knob only, easy-to-read at the rear side of the tool. Always full power in reverse - 3 position regulator for cautious forward assemblies. Air exhaust down the motor housing with swivelling air inlet - includes the option to assemble a silencing exhaust hose system. Well balanced design with insulating TPR (thermo-plastic rubber) grip areas on the handle for best control and ergonomical work. Swivel air inlet. Mini grease plug on the front housing for easy re-greasing of the impact mechanism.



Impact Wrench 1/2"

Model  
RC2277

Article no.  
8951000025

### TL - Torque Limited



demo video on  
[www.rodcraft.com](http://www.rodcraft.com)

The specialist:  
2263TL - Torque Limited - with limited torque in forward (max. 90 Nm) for safe and fast pre-tightening before using a torque wrench for final and precise torquing (as officially requested for safety). Making tyre changing more efficient and much faster while maintaining maximum safety (900 Nm max. for disassembly).

max. 90 Nm in forward  
max. 900 Nm in reverse 900 Nm

Model  
RC2263TL

Article no.  
8951077007



1050 Nm max.  
SmartDUOPACT  
1.9 kg

The Xtra innovative pack for the workshop with fast Smart DUOPACT mechanism. Your ultimate 1/2" tool with only 1,9 kg.

Impact Wrench 1/2"

Model  
RC2263Xi

Article no.  
8951077420

Model	Drive [inch]	Torque		Speed [min <sup>-1</sup> ]	Weight [kg]	Inner hose diameter [mm]	Dimension a x b x c [mm]	Air Consumption average - continuous [l/min]		Air inlet [inch]	Impact system	Noise LpA [dB(A)]	Vibration [m/s <sup>2</sup> ]
		M [Nm]	Mmax [Nm]					l/min	l/min				
RC2263TL	1/2"	max. 90	900	7800	1.9	8	190x185x70	170	515	1/4" IG	TL	93.3	13.96
RC2263Xi	1/2"	900	1050	8500	1.9	8	190x185x70	290	790	1/4" IG	SmartDP	93.7	9.05
RC2277	1/2"	900	1250	8200	2.0	8	194x188x70	245	760	1/4" IG	DP	93.0	9.2

# 3/4" Impact Wrenches

**700 Nm max.**  
**DUOPACT**



Small 3/4" impact wrench with 6 position torque regulator in forward.

Model **RC2305RE** Article no. **8951077440**

**1500 Nm max.**  
**DUOPACT**



Impact wrench for work on small trucks and vans. Comfortable handle with insulating rubber cover. Power regulator with 3 positions in forward and full power in reverse. The exhaust air is leaving the tool downwards from the handle.

Model **RC2315** Article no. **8951077130**

**1700 Nm max.**  
**PIN CLUTCH**



Well balanced lightweight Premium-Models with extra small front part allowing access to confined areas. Easy to control trigger for tightening with care. Double directional reduction of the impacting power possible by 2 position regulator.

Impact wrench 3/4" Model **RC2345** Article no. **8951077150**

**1800 Nm max.**  
**DUOPACT**



Very durable tools with powerful forged DUOPACT impact system. Equipped with ergonomic down-handle exhaust and a regulator for reduction of the impacting performance in forward operation (6 positions). Fast maintenance grease plug for servicing the impact system from outside.

Impact wrench 3/4" Model **RC2350** Article no. **8951077160**

**2373Xi**  
XTRA INNOVATION



**1950 Nm max.**  
**SmartDUOPACT**  
**composite**

Extremely powerful whilst lightweight and ideally suited to provide a fast service for small trucks and vans. With ergonomic down-handle exhaust that is also available with a silencing exhaust hose system. Including a fast maintenance grease plug for regreasing of the impact system from outside. The tool has an integrated forward/reverse shift/regulator on the back with 3 power positions.

with short anvil Model **RC2363Xi** Article no. **8951077520**  
with long anvil Model **RC2373Xi** Article no. **8951077532**



**Impact Socket Set 3/4":**  
8 piece set with impact proof sockets made of high steel grade (CrMo). All sockets are laser etched showing the model no. and size. Delivered in a tool case with metal clasps\* and individual socket moulds marked with each size. Set includes socket sizes: 26/27/29/30/32/35/36/38 mm

Set, short\* Model **RS618** Article no. **8951012358**  
Set, long Model **RS618D** Article no. **8951012359**



**Compressed air hoses**  
Only hoses with sufficiently large internal diameter provide enough compressed air for the pneumatic tool at the end of the line. Please see page 67.

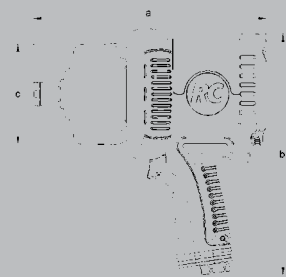

Model	Drive [inch]	Torque		Speed [min <sup>-1</sup> ]	Weight [kg]	Inner hose diameter [mm]	Dimension a x b x c [mm]	Air consumption average - continuous		Air inlet [inch]	Impact system	Noise LpA [dB(A)]	Vibration [m/s <sup>2</sup> ]
		M	M <sub>max</sub>					[l/min]	[l/min]				
RC2305RE	3/4"	490	700	6300	2.9	13	210x195x57	185	510	1/4" IG	DP	91.5	8.22
RC2315	3/4"	1100	1500	5600	4.7	13	242x230x78	340	990	3/8" IG	DP	91.1	9.97
RC2345	3/4"	1300	1700	6050	4.8	13	240x230x105	210	1000	3/8" IG	PC	95.1	7.07
RC2350	3/4"	1400	1800	5000	5.9	13	240x230x105	290	780	3/8" IG	DP	92.3	7.1
RC2363Xi	3/4"	1560	1950	5750	3.5	13	228x215x93	270	1190	3/8" IG	DP	94.3	17.33
RC2373Xi					4.3		305x215x93						



**2403Xi**  
XTRA INNOVATION



**1950 Nm max.**  
**SmartDUOPACT**  
**composite**



Fast and very light  
1" composite impact wrench like  
model 2363Xi.

Model **RC2403Xi** Article no. **8951077550**

**2450 Nm max.**



Group of tools with  
good price-power-ratio.  
Often favoured due to their  
well balanced construction and good  
performance. In-handle exhaust and power reducer with 3  
positions for each forward and reverse.

Variant **with short anvil** Model **RC2425** Article no. **8951077190**  
Variant **with long anvil** Model **RC2426** Article no. **8951077032**



**2600 Nm max.**  
**Closed Hammer System**

Extremely robust Premium Tools  
especially recommended for trucks  
and buses. With almost maintenance-free  
"Closed Hammer System".

The torque power can be adjusted in 3 positions  
in forward as well as in reverse.

Variant **with short anvil** Model **RC2439** Article no. **8951077200**  
Variant **with long anvil** Model **RC2449** Article no. **8951077042**



**2500 Nm**  
**6,9 kg**  
**SmartDUOPACT**  
**composite**

Universal power pack for truck and bus applications –  
the lightweight front part and the composite motor  
housing reduce the total weight to incredible 6.9 kg  
especially well suited for confined areas  
and over-head use.

SmartDUOPACT mechanism building-up torque  
fast and efficiently due to internal ball bearing.  
The rubber coated auxiliary handle is designed  
for super grip and can be shifted in positions  
by tightening only one screw.

Exhaust down the handle and ready-equipped to  
attach a silencing exhaust hose system (DUS26).

Variant **with short anvil** Model **RC2433Xi** Article no. **8951077500**



Model	Drive [inch]	Torque		Speed [min <sup>-1</sup> ]	Weight [kg]	Inner hose diameter [mm]	Dimension a x b x c [mm]	Air Consumption average – continuous		Air inlet [inch]	Impact system	Noise LpA [dB(A)]	Vibration [m/s <sup>2</sup> ]
		M	Mmax					[l/min]	[l/min]				
RC2403Xi	1"	1560	1950	5750	3.6	13	228x215x93	270	1190	3/8" IG	SmartDP	94.9	10.73
RC2425	1"	1715	2450	3200	9.4	13	312x270x119	370	1020	1/2" IG	SH	97.9	14.93
RC2426					10.6		460x270x119					96	12.8
RC2433Xi	1"	1800	2500	4000	6,9/7,1*	13	252x 260x108	410	1200	1/2" IG	Smart DP	97	12.76
RC2439	1"	1800	2600	5000	10.1	13	272x279x114	280	1047	1/2" IG	CH	98.6	11.36
RC2449					11.5		442x279x114					98.5	10.29

# 1" Impact Wrenches

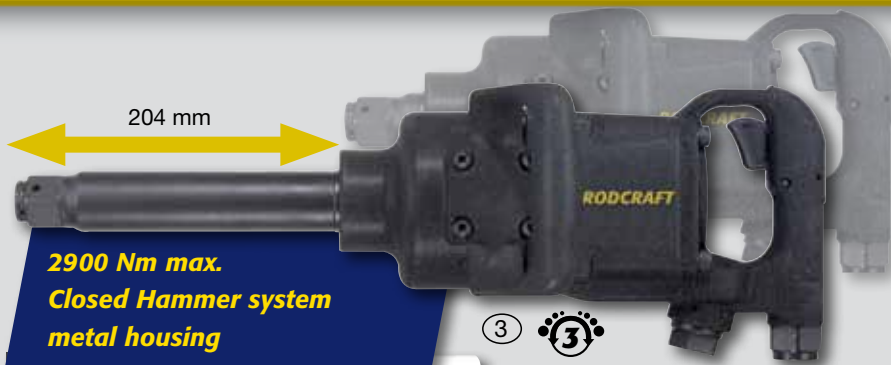

High performance tools with metal housing for use at forwarding companies and for servicing fleets of trucks and buses. Extremely robust due to almost maintenance-free "Closed Hammer System". The impacting power can be adjusted in 3 positions in forward as well as in reverse mode according to the application.

Variant	Model	Article no.
<b>with short anvil</b>	<b>RC2466</b>	8951000047
<b>with long anvil</b>	<b>RC2476</b>	8951000048



Strong 1" lightweight impact wrench. The tool for the professional tyre service on trucks and buses. Easy to shift with one hand (F/R) and with integrated 3 position power adjustment for tightening (forward). In reverse it delivers automatically full power.

Variant	Model	Article no.
<b>with long anvil</b>	<b>RC2484Xi</b>	8951077132



1" Impact wrench with excellent power-weight-ratio and super high 2900 Nm max. impacting power in reverse. Premium tool for the professional tyre service on trucks and buses. The long anvil and an extra slim front with only 89 mm diameter allow easy access. Equipped with a robust 3+3 position power regulator incorporating the F/R shift. Full 360° swiveling side handle suits all working positions. Ergonomic and insulating rubber cover on both handles and the motor housing made of lightweight alloy.

Variant	Model	Article no.
<b>with long anvil</b>	<b>RC2477Xi</b>	8951000046

All 1" impact wrenches on this page are equipped with a socket retainer for short term fixation of the accessory - practical for all applications where sockets are often changed.

Model	Drive [inch]	Torque		Speed [min <sup>-1</sup> ]	Weight [kg]	Inner hose diameter [mm]	Dimension a x b x c [mm]	Air Consumption average – continuous		Air inlet [inch]	Impact system	Noise LpA [dB(A)]	Vibration [m/s <sup>2</sup> ]
		M [Nm]	Mmax [Nm]					[l/min]	[l/min]				
RC2466	1"	2000	2900	5150	10.6	13	370x186x130	370	1130	1/2" IG	CH	100	6.5
RC2476							520x186x130						7.8
RC2477Xi	1"	2100	2900	5900	8.1	13	490x165x89	300	920	1/2" IG	DP	106	9.8
RC2484Xi	1"	1900	2800	5000	8.4	13	530x178x94	410	1200	1/2" IG	Smart DP	95.3	14.3



### Impact Socket Sets 1"

8\* piece and 4 piece sets with impact proof sockets made of high steel grade (CrMo). All sockets are laser etched showing the model no. and size. Delivered in a tool case with metal clasps\* and individual socket moulds marked with each size.

Set RS818\* includes short sockets of the sizes:

27, 30, 32, 33, 35, 36, 38, 41 mm

Set RS814D includes long sockets of the sizes:

27, 32, 33, 36 mm

	Model	Article no.
Set, short	RS818	8951012360
Set, long	RS814D	8951012361



### "LIFTMASTER"

For moving and positioning with ease - simple to use



Model	Article no.
RC2910	8951011015

suited for models:  
2425 / 2426 / 2439 / 2466 / 2476 / 2477Xi / 2485



**1"**  
**3500 Nm max.**  
**DUOPACT**



Big 1" impact wrenches for heavy duty trucks and construction machines. The impacting power can be reduced in both directions in 4 steps.

Variant	Model	Article no.
2950 Nm max.	RC2485	8951077240
3500 Nm max.	RC2490	8951077250



**1"**  
**3500 Nm max.**  
**Système**  
**Marteau fermé**



Extremely strong and durable pistol tool with "Closed Hammer System" for reduced maintenance. 4 position torque regulation for both directions

Model	Article no.
RC2444	8951077210



**1 1/2"**  
**3500 Nm max.**  
**DUOPACT**



Very strong tool for industrial and power plants as well as for threaded connections on track vehicles. Power regulation possible for both directions in 4 steps

Variant	Model	Article no.
3500 Nm max.	RC2585	8951077270



**1 1/2"**  
**5500 Nm max.**



Bull Power Tool for extremely high torques in industrial plants like chemical and petrochemical plants as well as power plants. The impacting power can be adjusted in 4 steps for both directions.

Model	Article no.
RC2530	8951077260

Model	Drive [inch]	Torque		Speed [min <sup>-1</sup> ]	Weight [kg]	Inner hose diameter [mm]	Dimension a x b x c [mm]	Air Consumption average - continuous		Air inlet [inch]	Impact system	Noise LpA [dB(A)]	Vibration [m/s <sup>2</sup> ]
		M [Nm]	Mmax [Nm]					[l/min]	[l/min]				
RC2444	1"	2450	3500	2700	14.6	13	325x300x121	400	1120	3/8" IG	CH	104	9.17
RC2485	1"	2065	2950	3300	13.0	19	410x230x100	330	930	1/2" IG	DP	98.5	15.4
RC2490	1"	2450	3500	3400	15.7	19	410x230x120	330	930	1/2" IG	DP	98.2	14.57
RC2585	1 1/2"	2450	3500	3400	16.6	19	460x235x120	330	930	1/2" IG	DP	96.2	15.21
RC2530*	1 1/2"	4200	5500	3600	17.7	19	520x190x123	600	1800	1/2" IG	PC	97.1	14.62

max. pressure 6.3 bar (90 psi) \* please ask for stock / delivery time IG : female thread  
norms applied : noise according to ISO15744, vibration 3-axis according to ISO28927-2, more detailed specs see page 69

# Cordless Impact Wrenches Tyre Inflators

**Set 1/2"**  
**Li-ion Power**  
**max. 575 Nm**

Power where you need it - Lightweight for mobile use. Cordless impact wrench 1/2" with comfortable rubber grip patch and professional quality with easy-to-change brushes on the motor, fast shifting with forward-reverse shift just above the trigger. Set of impact wrench in a sturdy case with 2 pcs. of rechargeable high-capacity Li-ion batteries (2.6 Ah-18 Volts) including a quick-analyzer for the remaining battery power, 1 pc. battery charger including cable - good for 100 - 240 Volts input.



**cordless impact wrench set**  
**2 pcs. Li-ion batteries 2,6 Ah/18V**  
**charger 100-240V with cable**

Model	Article no.
<b>RC9026</b>	<b>8951077560</b>
RC9025B	8951012351
RC9025C	8951012352

Model	Drive	Torque		Speed	Weight	a x b x c	Accu Voltage	Accu Capacity	Charging Time	Number of Bolts Size 21		Noise LpA	Vibration
		M	M <sub>max</sub>										
							<b>DC</b>						
	[inch]	[Nm]	[Nm]	[Rpm]	[kg]	[mm]	[V]	[Ah]	[h]	[nombre]	[nombre]	[dB(A)]	[m/s <sup>2</sup> ]
RC9026	1/2"	575	575	1700	2,2 (2,9)	254x80x269	18 Li-ion	2.6	1	150	150	87,9	4,26

weight: weight of tool (weight of tool including battery) norms applied : noise according to ISO15744, vibration 3-axis according to ISO28927-2

**certified tyre inflators**  
**with tyre valve clip**



Professional tyre fillers with 500 mm hose and valve clip - standard analogue, premium analogue and premium digital.

**Model RF02G** pressure range 0 - 10 bar, lightweight certified version with analogue 60 mm gauge and anti-shock-rim, push-button for tyre pressure release and lever for tyre filling.

**Model RFP04G** pressure range 1 - 11 bar, certified, shock-resistant version with easy to read, large pressure gauge (diameter 80 mm - 10 graduations per bar). High filling rate and long 1,5 m hose for comfortable and safe filling even of large tyres. Equipped with a hanger, easy to use broad metal lever for filling and button for pressure release - measuring continuously.

**Model RFP03DG** pressure range 0 - 12 bar, solid metal body, 3-function-lever (measurement-filling-release), full anti-shock rubber cover like RFG01G. With electronic pressure sensor and digital display, very easy to read and surpassing the requirements in precision of the European Union directive (0,01 bar). 3500 hours operation (mixed operation) with 2 x AAA batteries, with battery status indication and auto-start.



**digital - fast and precise**  
**high filling rate**



<b>Standard analogue, certified</b>	<b>Modl</b>	<b>Article no.</b>
<b>Premium analogue, certified</b>	<b>RF02G</b>	<b>8951011019</b>
<b>Premium digital-fast, high precision</b>	<b>RFP04G</b>	<b>8951012306</b>
	<b>RFP03DG</b>	<b>8951011020</b>

50 cm rubber filling hose with valve clip **8955510220**

150 cm rubber filling hose with tyre valve clip **8951012296**

Model	Max. Pressure	Weight	Inner Hose Diameter	Dimension a x b x c	Air Consumption average - continuous		Air Inlet	Duty Level	Nozzle
	[bar]	[kg]	[mm]	[mm]	[l/min]	[l/min]	[inch]	X	[mm]
RF02G	10	0.41	8	250	100	300	1/4" IG	2	tyre valve clip
RFP04G*	15	0.65	8	250x165x70	160	480/800**	1/4" IG	3	tyre valve clip
RFP03DG	15	0.69	8	245	100	375	1/4" IG	4	tyre valve clip

\* air filling hose 1.5m  
\*\* at 11 bar entrance pressure like for inflating truck tyres  
IG : female thread

## Safety Gloves



### Carpal-Tunnel Gloves - CT



3121

Size	Model	Description	Article no.
SM / 8	AVHCT-SM	CTS "Carpal Tunnel Syndrome" preventive technology. With thick protective gel pads with goat leather on the palm side. Breathable Neoprene® for unparalleled comfort.	8951011014
MD / 8,5	AVHCT-MD		8951011013
LG / 9	AVHCT-LG		8951011012
XL / 9,5	AVHCT-XL		8951011011
XXL / 10	AVHCT-XXL		8951011010

### Authentic Mechanic's Gloves - MHS

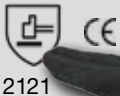

2121

Size	Model	Description	Article no.
SM / 8	MHS-SM	Unique split palm design enhances fit. Tough Spandex® top material resists snags. Fingers and palm pads made of Clarino® material.	8951011005
MD / 8,5	MHS-MD		8951011009
LG / 9	MHS-LG		8951011008
XL / 9,5	MHS-XL		8951011007
XXL / 10	MHS-XXL		8951011006

### Split Fit Air Mechanic's Gloves - SFA

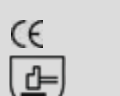

2222

Size	Model	Description	Article no.
SM / 8	SFA-SM	Unique split palm design enhances fit. Free Flex Airprene® knuckle and index finger protection system. 3 mm shock absorbing gel palm padding. Tough Spandex® top material resists snags.	8951011004
MD / 8,5	SFA-MD		8951011003
LG / 9	SFA-LG		8951011002
XL / 9,5	SFA-XL		8951011001
XXL / 10	SFA-XXL		8951011000

no bleach

do not iron

machine wash only in luke warm water

no tumble dry



CE and classification of the mechanical resistances according to DIN EN 420 / 388 against

A: abrasion  
B: cutting

C: tearing  
D: puncture

classes from 1 (low resistance) - 4 (high resistance)

Determine the glove size: Place the right hand here as shown and read the glove size

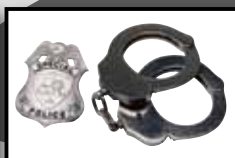

XXL-10

XL-9.5

LG-9

MD-8.5

SM-8

# 1/4" and Mini-Ratchets

only 140 mm



②

Mini ratchet for use in confined areas. Fast assembly and disassembly with 270 rpm, 30 Nm max. motor torque. Anti-slip coated handle, insulating against cold with rear exhaust.

Variant Model Article no.  
1/4" square drive RC3001 8951078022



motor 30 Nm max.



①

The right ratchet for any application. With short (180 mm) or alternatively long (205 mm) design. Includes an adapter for attaching an silencing exhaust hose system.

Variant Model Article no.  
1/4" square drive with short front RC3000 8951078012  
with long front RC3015 8951078052

closed head design  
motor 45 Nm max.  
composite



③

Flat, small ratchet head (32 mm) for confined areas. The closed head design with 2 grease nipples makes regreasing of all ratchet head parts from outside easy and keeps dirt off the mechanism for an extended durability of the ratchet. Pivotal air outlet, keeps air away from work, with the possibility to connect a silencing exhaust hose system. Insulated handle with integrated power adjustment.

Variant Model Article no.  
1/4" square drive RC3060 8951078062

## Maintenance Units

A must for any professional use of air tools - particularly small tools need constantly clean air and lubrication of the motor due to their tighter construction and usually high speed.

See page 65



## Mini-Grease Gun

Especially for greasing of ratchet heads, impact systems and angular gears.

See page 68



## Swivel Connector

Ideal for tools which can be used in all directions.

See page 64



## Accessories for

3/8" and 1/2" large range of sockets, adapters and extensions. See page 55

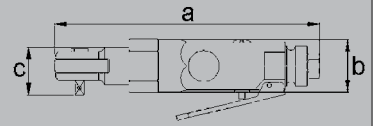

Model	Drive	Torque M Mmax	Speed	Weight	Inner hose diameter	Dimension a x b x c	Air consumption average - continuous	Air inlet	Duty level extras	Noise LpA	Vibration
	 [inch]	 [Nm]	 [min <sup>-1</sup> ]	 [kg]	 [mm]	 [mm]	 [l/min]	 [inch]	 X	 [dB(A)]	 [m/s <sup>2</sup> ]
RC3000	1/4"	20 30	230	0.55	8	180x35x31	100 300	1/4" IG	1	81.2	83.2
RC3001	1/4"	25 30	270	0.44	8	140x35x30	115 490	1/4" IG	2	91.8	92.2
RC3015	1/4"	20 30	230	0.55	8	205x35x31	100 300	1/4" IG	1	82.4	82.1
RC3060	1/4"	20 45	250	0.65	8	205x42x32	65 200	1/4" IG	4 GK	89.3	88.1

GK: "closed head" design

norms applied : noise according to ISO15744, vibration 3-axis according to ISO28927-2, more detailed specs see page 69



### Impact Socket Sets 3/8"

13 piece set with impact proof sockets made of high steel grade (CrMo). Delivered in a tool case, with individual socket moulds marked with each size. All sockets are laser etched showing the model no. and size.

Set includes socket sizes:

7/8/9/10/11/12/13/14/15/16/17/18/19 mm

Set, short	Model	Article no.
Set, long	RS3113	8951012354
	RS3113D	8951012355



### Sets

All sets mentioned here include:

- 1 air ratchet
- 7 sockets with sizes 10/ 11/ 12/ 13/ 15/ 17/ 19 mm
- 1 extension shaft 75 mm
- 1 universal joint
- 1 holder for bits (1/4" hex)
- 1 tool box



**motor 30 Nm max.**



The right ratchet for any application. With short (180 mm) or alternatively long (205 mm) design. Includes an adapter for attaching an silencing exhaust hose system.

Variant	Model	Article no.
3/8" square drive with short front	RC3005	8951078042
with long front	RC3010	8951078013



**closed head design  
motor 45 Nm max.  
composite**

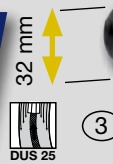

Flat, small ratchet head (32 mm) for confined areas. The closed head design with 2 grease nipples makes regreasing of all ratchet head parts from outside easy and keeps dirt off the mechanism for an extended durability of the ratchet. Pivotal air outlet, keeps air away from work, with the possibility to connect a silencing exhaust hose system. Insulated handle with integrated power adjustment.

Variant	Model	Article no.
3/8" square drive	RC3260	8951078033



**motor 60 Nm max.**



Series of standard ratchets with exhaust towards the front and good grip handle structure.

Variant	Model	Article no.
3/8" square drive	RC3200	8951078023



**motor 90 Nm max.**



Proven air ratchets with rear exhaust and the possibility to attach a silencing exhaust hose system - which all "RE"-types include already as well as a protective rubber cap on the ratchet head. The motor housing with its flattened sides has a perfect grip to allow best control of the tool.

Variant	Model	Article no.
3/8" square drive	RC3630	8951078054

Model	Drive	Torque M M <sub>max</sub>	Speed n <sub>0</sub>	Weight kg	Inner hose diameter	Dimension a x b x c	Air consumption average - continuous	Air inlet	Duty level extras	Noise LpA	Vibration
	[inch]	[Nm]	[min <sup>-1</sup> ]	[kg]	[mm]	[mm]	[l/min]	[d'impact]	(x)	[dB(A)]	[m/s <sup>2</sup> ]
RC3005	3/8"	20 30	230	0.55	8	180x35x33	100 300	1/4" IG	1	85.5	87.5
RC3010	3/8"	20 30	230	0.55	8	205x35x33	100 300	1/4" IG	1	84.2	83.2
RC3200	3/8"	40 60	160	1.20	8	255x47x42	170 465	1/4" IG	1	90.8	92.8
RC3260	3/8"	20 45	250	0.65	8	205x42x34	65 200	1/4" IG	4 GK	92.5	93.4
RC3630	3/8"	60 90	170	1.25	8	273x40x45	170 460	1/4" IG	2	85.9	82.8

IG: female thread AG = male thread H: hand torque GK: "closed head" design

RE: including silencing exhaust hose system ("DUS") adds 0.2 kg, without exhaust hose system approx. +4 dB(A) max. pressure 6.3 bar (90 psi)

norms applied : noise according to ISO15744, vibration 3-axis according to ISO28927-2, more detailed specs see page 69

# 1/2" Ratchets

**motor 60 Nm max.**

①



Series of standard ratchets with exhaust towards the front and good grip handle structure

Variant Model Article no.  
**1/2" square drive RC3100 8951078004**

**Motor 90 Nm max.**

② 



Proven air ratchets with rear exhaust and the possibility to attach a silencing exhaust hose system - which all "RE"-types include already as well as a protective rubber cap on the ratchet head. The motor housing with its flattened sides has a perfect grip to allow best control of the tool.

Variant Model Article no.  
**1/2" square drive RC3600RE 8951078104**  
**RC3600 8951078034**  
**in set RC3601RE 8951178014**



**motor 90 Nm max. composite + rubber**

② 



Ergonomic and powerful ratchet wrench for every workshop. New and cold-insulating composite handle with integrated rubber patches for better grip. Start lever sinks snugly into housing. Simple to re-grease the mechanism through the mini-grease plug in the ratchet head. The introduced grease protects the mechanism from abrasive dirt and dust penetrating the ratchet head and reduces wear. Due to the rear exhaust design a silencing exhaust hose can be attached (DUS 21).

Variant Model Article no.  
**1/2" square drive RC3607 8951078114**

**motor torque 130 Nm max. hand torque over 250 Nm DuoPawl**

④



Fastest ratchet in the RODCRAFT program with extremely high power of the motor - by hand you can even torque more than 250 Nm almost like using a spanner. The Premium model 3700 combines all latest RODCRAFT improvements: DUO-PAWL double ratchet pawl mechanism with 3-point-spring suspension for extreme torque and smooth operation with symmetrical blocking system. The closed head design keeps dirt off the mechanism and the 3 mini-grease nipples offer easy and fast maintenance from outside. The forged head and its construction ensure optimum stability and small dimensions for working with high power even in confined areas. The cold and vibration insulated handle is equipped with a swiveling exhaust ring avoiding any disturbance from the exhausted air flow.









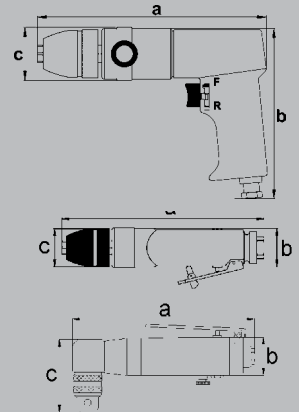

Variant Model Article no.  
**1/2" square drive RC3700 8951078074**

## Balancers



All tools marked with the hook logo can also be used in combination with balancers to suspend them for a more ergonomic and efficient work. See page 63



Model	Drive  [inch]	Torque		Speed  [min <sup>-1</sup> ]	Weight  [kg]	Inner hose diameter  [mm]	Dimension a x b x c  [mm]	Air consumption average - continuous.		Air inlet  [inch]	Duty level extras  x	Noise LpA  [dB(A)]	Vibration  [m/s <sup>2</sup> ]
		M  [Nm]	M <sub>max</sub>  [Nm]					l/min	l/min				
RC3100	1/2"	40	60	160	1.20	8	255x47x46	170	465	1/4" IG	1	93.2	95.2
RC3600RE	1/2"	60	90	170	1.25	8	275x43x49	170	460	1/4" IG	2	85.4	85.5
RC3607	1/2"	60	90	170	0.9	8	270x44x49	170	460	1/4" IG	2	88.2	87.8
RC3700	1/2"	130 250(H)	130	320	1.6	8	312x52x52	130	830	1/4" IG	4 GK DuoPawl	92	93.7

IG: female thread AG = male thread H: hand torque GK: "closed head" design

RE: including silencing exhaust hose system ("DUS") adds 0.2 kg, without exhaust hose system approx. +4 dB(A) max. pressure 6.3 bar (90 psi)

norms applied : noise according to ISO15744, vibration 3-axis according to ISO28927-2, more detailed specs see page 69





**6.5 mm reversible composite + rubber**

Ergonomic and lightweight drill with insulating composite handle equipped with integrated rubber contact surfaces. Precise to regulate the speed. Well suited for use with balancers/hose balancers due to its 3 connecting possibilities for compressed air supply.

Model **RC4105** Article no. **8951073001**



**10 mm non-reversible**

Very handy drill with good price/performance ratio including a RÖHM® - quick chuck up to 10 mm (3/8"). Short design

Model **RC4100** Article no. **8951073000**



**10 mm reversible**

Compact tool with forward/reverse switch on handle and equipped with RÖHM®-quick chuck up to 10 mm (3/8").

Model **RC4500** Article no. **8951073021**



**10 mm reversible composite + rubber**

Very ergonomic and lightweight tool with anti-slip rubber patches integrated in the handle. Precisely adjustable speed for cautious start-ups. With silencer and multiple connection possibilities for the compressed air practical according to the direction of use as well as the way of suspension (hose balancer / balancer and spiral hose / hand held). Equipped with high quality key-less chuck from "RÖHM®".

Model **RC4107** Article no. **8951073011**



**silenced non-reversible**

High quality drill with double front bearing, 3-planet-gear and down-handle exhaust with muffler. Equipped with 10 mm (3/8") quality RÖHM® - quick key-less chuck.

Model 4607 with cold-insulating composite handle with integrated rubber patches for better grip.

Model **RC4600** Article no. **8951073040**  
 Model **RC4607** Article no. **8951073090**

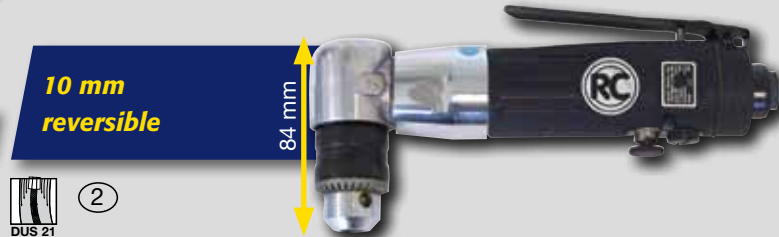

**10 mm reversible**

Slim tool with adapter to attach a silencing exhaust hose system. With RÖHM® - quick key-less chuck up to 10 mm (3/8") (male thread on tool 3/8"-24).

Model **RC4650** Article no. **8951073050**

Model	Drill diameter 1	Power	Speed	Weight	Inner hose diameter	Dimension a x b x c	Air consumption average - continuous.	Air inlet	Duty Level	Noise	Vibration
	[mm]	[W]	[min <sup>-1</sup> ]	[kg]	[mm]	[mm]	[l/min]	[inch]	(x)	LpA [dB(A)]	[m/s <sup>2</sup> ]
RC4100	SF 1 - 10	500	2200	0.95	8	193x132x42	350 470	1/4" IG	2	86.7	3.19
RC4105	ZF 1 - 6.5	180	3000	0.58	6 - 9	165x160x38	330 440	1/4" IG	3	71.3	3.24
RC4107	SF 1 - 10	380	2200	0.93	8	220x100x50	480 650	1/4" IG	3	81,3	3.06
RC4500	SF 1 - 10	500	2000	1.15	8	192x152x42	460 620	1/4" IG	2	92.7	3.16
RC4600	SF 1 - 10	500	2000	1.00	8	225x40x42	380 510	1/4" IG	2	81.3	3.37
RC4607	SF 1 - 10	500	2000	1.00	8	225x40x42	380 510	1/4" IG	2	81.3	3.37
RC4650	ZF 1 - 10	500	1500	1.10	8	210x42x84	330 450	1/4" IG	2	89.9	3.14

1 chuck with thread 3/8" x 24 IG max. pressure 6.3 bar (90 psi) SF: key-less chuck ZF: key chuck  
 norms applied : noise according to ISO15744, vibration 3-axis according to ISO28927-2, more detailed specs see page 69

# Drills 13 mm (1/2")

**silenced  
non-reversible**

②

Compact 13 mm (1/2")  
Drill with down-handle  
exhaust muffler.  
Equipped with quality RÖHM® - quick key-less chuck,  
robust 3-planet-gear and double front bearing.

Model Article no.  
**RC4300** 8951073020



**non-reversible**

③

Powerful 13 mm (1/2") drill  
with double planetary gear and low speed,  
also good for mixing applications.  
With quality RÖHM® - quick key-less chuck and  
detachable side handle.

Model Article no.  
**RC4400** 8951073030



**reversible**

③

Reversible 13 mm (1/2")  
drill with double 3-planet-gear and  
double front bearing for tough applications.  
With precise RÖHM® - quick key-less chuck and  
detachable side handle.

Model Article no.  
**RC4550** 8951073031



## Drill Chuck with Precision

Fast key-less chuck  
with good grip from  
"RÖHM®"



Type  
up to 10 mm  
up to 13 mm

Article no.  
8951011458  
8951011459

Key chuck



Type  
up to 6,5 mm  
up to 10 mm  
up to 13 mm

Article no.  
8951011473  
8951011451  
8951011452

key



8951011453

## Spot Weld Drill and accessory

Removing an  
element from the  
car body without  
damaging the remaining  
body parts, see our  
RODCRAFT spot weld drill models  
6450 - 6453 on page 27

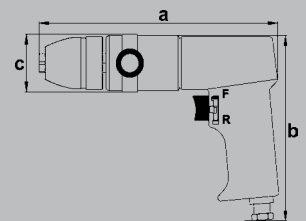

Model	Drill diameter <sup>1</sup>  [mm]	Power  [W]	Speed  [rpm]	Weight  [kg]	Inner hose diameter  [mm]	Dimension a x b x c  [mm]	Air consumption average - continuous  [l/min]	Air inlet  [inch]	Duty level  X	Noise LpA  [dB(A)]	Vibration  [m/s <sup>2</sup> ]
RC4300	SF 1.5 - 13	500	2000	1.25	8	175x170x44	360 480	1/4" IG	2	87	3.17
RC4400	SF 1.5 - 13	500	500	1.65	8	235x147x44	400 530	1/4" IG	3	82.3	4.51
RC4550	SF 1.5 - 13	500	800	1.40	8	220x150x42	430 585	1/4" IG	3	91.9	4.51

<sup>1</sup> chuck with thread 3/8" x 24 IG max. pressure 6.3 bar (90 psi) SF: key-less chuck ZF: key chuck IG: female thread norms applied: noise according to ISO15744, vibration 3-axis according to ISO28927-5, more detailed specs see page 69

### Spiral Hoses

Our high quality polyurethane spiral hoses with straight ends are excellently suited for use with screwdrivers in combination with our balancers.

Due to their low resistance to the pulling force and their small diameter of the spiral they are very practical and comfortable to use. See page 67



### Balancers

In order to design an ergonomic and efficient work place especially the straight screwdrivers often require to be equipped with balancers in combination with spiral hoses with straight ends or with hose balancers. See page 63

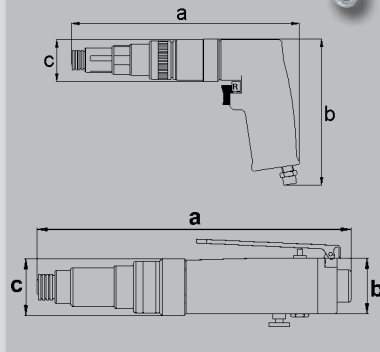

**up to 20 Nm**  
**internally adjustable**  
**1800 rpm**

②

Favoured short screwdriver with high speed

Model  
**RC4700**

Article no.  
8951073002



**up to 45 Nm**  
**externally adjustable**

②

Versatile smooth running tool with enormous power. Easy to reach forward/reverse shift, which can be operated by left and right handed persons.

Model  
**RC4780**

Article no.  
8951073003



**lightweight – composite external adjustment up to 15 Nm**

③

Super lightweight, ergonomic tool with precisely adjustable speed up to 1770 rpm. Well suited also for use with balancer / hose balancer – the tool offers 3 possible connections to compressed air supply.

Model  
**RC4784**

Article no.  
8951073023



**up to 17 Nm**  
**internally adjustable**  
**1800 rpm**

②

Large straight tool, for fast assembly. Easy to reach forward/reverse shift which can be locked in reverse for longer disassemblies.

Model  
**RC4760**

Article no.  
8951073012

All above listed screw drivers are equipped with a quick coupler for screw driver bits. The motor activated by button start system and the bit start turning as soon as you push onto the screw. The memorised shut-off torque can be adjusted internally (remove front cap) i.e. these screw drivers are good for repetitions of the same torque like when using the same screw size in a series. All screwdrivers are equipped with a forward/reverse switch. The exhausted air is guided through the handle and through an adapter which allows to attach a silencing exhaust hose system. An exhaust hose system will reduce the disturbance of cold exhausted air significantly for increased working comfort.

Model	Torque	Bit Drive	Adjustment	Speed	Weight	Inner hose diameter	Dimensions a x b x c	Air Consumption average – continuous	Air inlet	Stop / Start	Noise LpA	Vibration
	[Nm]			[rpm]	[kg]	[mm]	[mm]	[l/min]	[inch]		[dB(A)]	[m/s <sup>2</sup> ]

Pistol type screwdrivers												
RC4700 <sup>1/3</sup>	8 - 20	1/4"	Interne	1800	1.15	8	210x150x42	430 585	1/4" IG	R/D	88.6	< 2.5
RC4780 <sup>1/3</sup>	4 - 45	1/4"	externe	1100	1.45	8	245x155x43	430 585	1/4" IG	R/D	89.7	< 2.5
RC4784	1 - 15	1/4"	externe	1770	0.92	8	165x160x45	440 595	1/4" IG	R/M	80.3	< 2.5

Straight screwdrivers												
RC4760 <sup>1/3</sup>	4 - 17	1/4"	Interne	1800	1.10	8	242x42	350 470	1/4" IG	R/H	88.7	< 2.5

for 1/4" bits: 1 with quick-change-chuck 2 magnet holder standard 3 magnet holder accessory max. pressure 6.3 bar (90 psi)

R: shut-off by slip clutch A: air shut-off and (push-to-start) IG: female thread

D: motorstart per push button and proof H: motorstart per lever and proof

norms applied: noise according to ISO15744, vibration 3-axis according to ISO28927-5, more detailed specs see page 69

# Chisel Hammers and Sets

## car body / metal



### Set with hexagon chisels (11 mm):

- 1 chisel Hammer RC5100
- with spring retainer RC70
- 1 deriveting chisel RC22S
- 1 welding spot splitting chisel RC19S
- 1 double blade cutting chisel RC60S
- 1 flat chisel RC20S
- 1 curve splitting chisel RC18S
- 1 tool box

## truck brake pads / rivets



### Riveting Set for Truck Brake Pads

- Riveting Set for Truck Brake Pads  
For riveting and removal of hollow aluminium and copper rivets.  
Standard for rivet size 8 mm (also chisels available for 6 and 10 mm) with hexagonal shaft chisels (11 mm):
- 1 chisel hamer RC5100
  - with spring retainer RC70
  - 1 rivet head RC40S-8 mm (6 / 10 mm\*)
  - 1 deriveter chisel RC41S-8 mm (10 mm\*)
  - 1 counter holder RC42S-8 mm
  - 1 tool box
- \* optional sizes see page 57

## stone / concrete



### Set with hexagon chisels (11 mm):

- 1 chisel Hammer RC5100
- with steel retainer RC76-1
- 1 pointed chisel 240 mm SS10
- 1 flat chisel 240x20 mm SS20
- 1 flat chisel 240x30 mm SS30
- 1 flat chisel 240x40 mm SS40
- 1 groove chisel 240 mm SS50
- 1 tool box

Set hexagon 11,0 mm Model **RC5120** Article no. 8951171013

Set hexagon 11,0 mm Model **RC5160** Article no. 8951171033

Set hexagon 11,0 mm Model **RC5150** Article no. 8951171023



**6 Joule**

②

Compact chisel hammer with adjustable blow power. Including a chisel retainer spring model RC70. For use with chisels having a 11.0 mm hexagon shank.

Variante hexagon shank 11,0 mm Model **RC5100** Article no. 8951071022



**low vibration 8 Joule**

③

Vibration reduced chisel hammer well balanced and powerful for less tiring work. Suited for operation on sheet metal, metal and stone/concrete. This model is a comfortable and ergonomic alternative using chisels with 11,0 mm hexagonal shaft like in many of our sets. Including chisel retainer spring RC70.

Model **RC5180** Article no. 8951071052

Model	Chisel insert	Piston	Blows	Weight	Inner hose diameter	Dimension a x b x c	Air consumption average - continuous	Air inlet	Blow energy	Noise LpA	Vibration
		stroke/diam.									
	[mm] [inch]	[mm]	[min <sup>-1</sup> ]	[kg]	[mm]	[mm]	[l/min]	[inch]	[J]	[dB(A)]	[m/s <sup>2</sup> ]
RC5100	11.01 (0.433)	60/19	3000	1.50	8	200x160x39	270 400	1/4" IG	6	94.8	13.2
RC5180 A-V	11.01 (0.433)	81/19	2500	2.40	8	245x162x39	250 362	1/4" IG	8	100	3.2

### Chisel Hammer Accessory

Single chisels - with round shank insert or with hexagonal shank insert, with square shank insert, various sizes and types  
Retainers - spring type, chuck type, solid ones  
see page 57

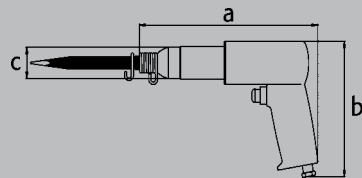

### Needle Scaling Attachment

Scaling rust and old paint or treating surfaces with a normal chisel hammer.  
Contains 19 needles with 3 mm.  
Suited for all RODCRAFT chisel hammers with 11 mm hexagonal chisel insert.



Model **5605** Article no. **8951076000**

**6 Joule**  
**9 Joule**

③

Hammers with extra long stroke and adjustable impacting power, easy to control. Designed for hexagonal chisel inserts 11,0 mm.  
Including hammer spring RC70.

Variant	Model	Article no.
<b>6 Joule</b>	<b>RC5170</b>	<b>8951071032</b>
<b>9 Joule</b>	<b>RC5175</b>	<b>8951071042</b>

**stone / concrete**



**Set with:**  
**hexagon shank chisels (11 mm):**  
1 chisel hammer, high power 9 Joule  
with massive steel safety chisel holder  
1 pointed chisel 240 mm  
1 flat chisel 240x20 mm  
1 tool box

Model	Article no.
<b>RC5176</b>	<b>8951171043</b>

**6 Joule**

③

Small straight hammer for metal, stone and concrete applications.  
With steel safety holder RC76-3 and connecting clamp RC79.  
For larger chisels with 12.0 mm hexagon shank and exchangeable cylinder bushing.

Model	Article no.
<b>RC5305</b>	<b>8951071065</b>

**stone / concrete**



**Set with:**  
**hexagon shank chisels (12 mm):**

1 chisel hammer, 6 Joule		RC5305
with massive steel safety chisel holder		RC76-3
1 pointed chisel, concrete	235 mm	RC51S
1 flat chisel, concrete	235x20 mm	RC52S
1 flat chisel, concrete	235x30 mm	RC53S
1 flat chisel, concrete	235x40 mm	RC54S
1 tool box		

Model	Article no.
<b>RC5310</b>	<b>8951171053</b>

**22 Joule**

③

Large straight hammer for chisel insert size 14,7 mm hexagonal.  
For metal, stone and concrete applications as well as heavy duty driving of bushings, casted metal parts, weldings, plaster and walls.  
Equipped with steel safety holder RC94 and connecting clamp RC95.

Model	Article no.
<b>RC5400</b>	<b>8951071076</b>

Model	Chisel insert [mm] [inch]	Piston stroke/ diam. [mm]	Blows [min <sup>-1</sup> ]	Weight kg [kg]	Inner hose diameter [mm]	Dimensions a x b x c [mm]	Air consumption average - continuous [l/min]	Air inlet [inch]	Blow energy [J]	Noise LpA [dB(A)]	Vibration [m/s <sup>2</sup> ]
RC5170	11.01 (0.433)	68/19	3000	1.70	8	180x160x39	240 360	1/4" IG	6	100	3.8
RC5175	11.01 (0.433)	94/19	2100	2.05	8	250x160x39	260 380	1/4" IG	9	97.3	3.7
RC5305	12.01 (0.472)	50/20	3000	2.55	8	294x150x44	260 380	1/4" IG	6	98.8	3.6
RC5400	14.71 (0.579)	76/29	1700	7.50	13	420x175x57	480 720	3/8" IG	22	99	13.8

<sup>1</sup> Hexagon shank chisel insert max. pressure 6.3 bar (90 psi) IG: female thread  
norms applied : noise according to ISO15744, vibration 3-axis according to ISO28927-9, more detailed specs see page 69

# Engraving Pens, Scrapers, Hammers



**reaction-free  
engraves also on steel**

②

Engraving pen with very hard needle even works on steel. Operates like a mini-hammer without giving reactions sideways. Anti-slip structured handle and start valve ring at the end of the tool. Extra hard replacement needles available as accessory.

Model **RC5030** Article no. **8951071010**  
engraver incl. 1 engraving needle  
engraving needle, extra hard **8951011487**



**combination**

②

High quality straight chisel hammer equipped with angled scraper chisel and needle scaler set with 19 needles, size 3 mm. (technical details on page 22)

scraper with 2 scraper blades **Model RC5610** Article no. **8951076001**  
scraper chisel 30 mm, angled **RC5607** **8951011499**  
flat chisel 20 mm **RC5602** **8951011497**



**one piece, long, for work on floor**

②

**RC5550**

Scraper and chisel hammer for the removal of various surfaces and layers like tiles and bitumen from tanks, floors and walls. Chisel inserts are available: from pointed chisels up to 120 mm flat chisels (see box right). The tool is available in two versions, long version for working on floors and a two-piece short version for working horizontally at shorter distance. (chisels not included in delivery)

With long robust one-piece handle bar (1080 mm without chisel) **Model RC5550** Article no. **8951076018**  
With separable handle bar (475 - 1080 mm without chisel) **RC5551** **8951076019**



**RC5551**

**three-piece, short/long, also for confined areas**

②

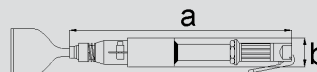

## Needle Scaler

More aggressive than sand blasting, finer than a scaling hammer - for removal of rust and coatings of many kind - without grinding away details - only good for solid metal, not applicable for thin sheet metal. Needs clean and well lubricated air. Maintenance units see page 64

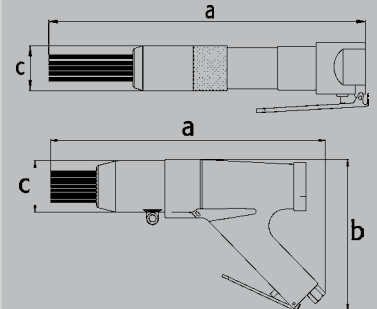

## Rust removal on sheet metals:









Patented remover system MBX. Not only for rust removal on sheet metals and car bodies see page 35/36

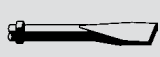

## Accessory for 5550/5551

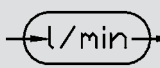
Type flat chisel **Model RC510** Article no. **8951011957**  
(260 mm long x 100 mm width)



Model	Chisel insert	Piston	Blows	Weight	Inner hose diameter	Dimension a x b x c	Air consumption average - continuous	Air inlet	Duty level	Noise	Vibration
	 [mm] [inch]	stroke/ diam. [mm]	 [min <sup>-1</sup> ]	 [kg]	 [mm]	 [mm]	 [l/min]	 [inch]	 X	 [dB(A)]	 [m/s <sup>2</sup> ]
RC5030	3.2	0.05	10000	0.20	8	160x14,5	4 5	1/4" AG	2	70.7	3.8
RC5550	14.71 (0.579)	40	2200	5.75	8	1080x62	100 160	1/4" IG	2	87.5	15.9
RC5551	14.71 (0.579)	40	2200	4.05 5.80	8	475x62 1080x62	100 160	1/4" IG	2	94	22.5

1 hexagon shank chisel insert max. pressure 6.3 bar (90 psi) model 5030 max. 4.1 bar IG: female thread AG: male thread norms applied : noise according to ISO15744, vibration 3-axis according to ISO28927-9, more detailed specs see page 69.

**12 x 3 mm**

①

Small straight needle scaler for wheel rims, frames and for working at limited space.

**needle scaler**  
**needle set 12 needles / 3 mm**  
**needle plate 12 hole / 3 mm**

Model Article no.  
**RC5615** 8951076002  
**RC5615 ST** 8951011498  
**RC5615 P3** 8951011511

**19 x 3 mm**

**+ 30 mm scraper chisel**

②

Combination tool that can be used for two cleaning processes with one. Scraping off layers e.g. of rust from flat surfaces as well as picking rust or old paint away from areas around details like bolts and screws with 19 needles.

**combination tool**  
**needle set 19 needle / 3 mm**  
**needle plate 19 hole / 3 mm**  
**scraper chisel 30mm, angled**  
**flat chisel 20 mm**

Model Article no.  
**RC5610** 8951076001  
 8940159860  
**RC5610 P3** 8951011510  
**RC5607** 8951011499  
**RC5602** 8951011497

**2 needle sets: 28 x 3 mm**  
**14 x 4 mm**

②

Powerful needle scaler, pistol type for rough removals (14 x 4 mm needles) and large surfaces (28 x 3 mm needles).

**needle scaler**  
**needle set 28 needles / 3 mm**  
**needle plate 28 hole / 3 mm**  
**needle set 14 Nadeln / 4 mm**  
**needle plate 14 hole / 4 mm**

Model Article no.  
**RC5620** 8951076003  
**RC5620 ST3** 8951011500  
**RC5620 P3** 8951011502  
**RC5620 ST4** 8951011501  
**RC5620 P4** 8951011503

**2 needle sets: 29 x 2 mm**  
**19 x 3 mm**

②

Especially suited to work out many details (29 x 2 mm needles). Insulated handle and front exhaust.

**needle scaler**  
**needle set 29 needles / 2 mm**  
**needle plate 29 hole / 2 mm**  
**needle set 19 needles / 3 mm**  
**needle plate 19 hole / 3 mm**

Model Article no.  
**RC5625** 8951076004  
**RC5625 ST2** 8951011504  
**RC5625 P2** 8951011512  
 8940159860  
**RC5625 P3** 8951011513











**35 x 4 mm**  
**(49 x 3 mm)**

②

Very Powerful and efficient needle scaler, pistol type with many large needles for the fast removal of thicker layers of rust / coatings. Included in the delivery are: 35 needles / 4 mm. Available as extra accessory is a needle set with 49 needles / 3 mm.

**needle scaler**  
**needle set 49 needles / 3 mm**  
**needle plate 49 hole / 3 mm**  
**needle set 35 needles / 4 mm**  
**needle plate 35 hole / 4 mm**

Model Article no.  
**RC5630** 8951076005  
**RC5630 ST3** 8951011506  
**RC5630 P3** 8951011508  
**RC5630 ST4** 8951011507  
**RC5630 P4** 8951011509

Model	Needle diameter  [mm]	Number of needles  [mm]	Blows  [min <sup>-1</sup> ]	Weight  [kg]	Inner hose diameter  [mm]	Dimension a x b x c  [mm]	Air consumption average – continuous  [l/min]	Air inlet  [inch]	Duty level 	Noise LpA  [dB(A)]	Vibration  [m/s <sup>2</sup> ]
RC5610	3	19	4000	2.55	8	468x44	190 280	1/4" IG	2	89.5	16.8
RC5615	3	12	4000	1.30	8	290x35	120 180	1/4" IG	1	88.1	11.4
RC5620	3 4	28 14	4500	3.60	13	345x180x61	200 300	3/8" IG	2	97.6	13.7
RC5625	2 3	29 19	3000	2.70	8	320x175x47	120 170	1/4" IG	2	94	17.7
RC5630	3 4	49 35	2200	6.00	8	490x171x67	200 300	1/4" IG	2	99.6	27.8

max. pressure 6.3 bar (90 psi) IG: female thread

norms applied : noise according to ISO15744, vibration 3-axis according to ISO28927-9, more detailed specs see page 69

# Stapler, Brad Nailer Pruning Shear



3

High quality stapler for staples with size 12.7 mm (type 80) and big magazine for 160 staples. With safety trigger, insulated handle and swivelling exhaust port (360°) for high comfort. Well suited for upholstery work, furniture and wooden box manufacturers. Possible staple lengths (A): 6-16 mm.

**for 160 staples  
Type 80**

short nose 20 mm



Model **RC5900** Article no. **8951076006**

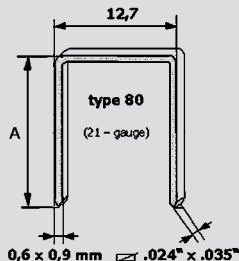

Every stapler and nailer mentioned here comes in a tool box.



3

Combination nailer and stapler (1 mm wire) with big magazine for 100 nails or 100 staples alternatively. Multiple-shot - see image below - for fast series of shots by simply touching the workpiece with the activator at the nose tip (bounce fire) - can be switched off for single shot operations. With insulated handle and swivelling exhaust port for high comfort. Well suited for upholstery work, furniture and wooden box manufacturers. Possible staples lengths (A): 16-38 mm, possible nails lengths (A): 15-40 mm.

Model **RC5940** Article no. **8951076007**

**combination  
for 100 nails  
or 100 staples alternatively**



brads (18 Gauge)

staples (18 Gauge)

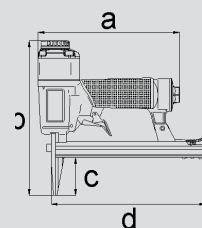
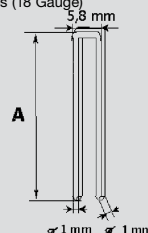
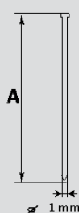

Model	Fasteners width (height)  [mm]	Load capacity  [pcs]	Weight  [kg]	Inner hose diameter  [mm]	Dimension a x b x c x d  [mm]	Air consumption  [l/stroke]	Air inlet  [inch]	Duty level  3	Noise LpA  [dB(A)]	Vibration  [m/s <sup>2</sup> ]
RC5900	K 12,7 (6 - 16) Typ 80 / 21 Gauge	K 160	0.8	8	189x148x20x208	0.8	1/4" IG	3	81.3	4.01
RC5940	K 5,8(16-38) J 1(15-40) 18 Gauge	K 100 J 100	2.1	8	217x246x27x225	1.3	1/4" IG	3	85.9	3.92

max. pressure 6.3 bar (90 psi) K: staples J: brads IG: female thread

norms applied : noise according to noise according to ISO15744, vibration 3-axis according to ISO28927-1, more detailed specs see page 69

**for wood,  
twigs and also plastics**

2



pruning shear

Model **RC6220** Article no. **8951076010**

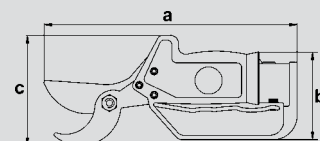

Model	Cutting speed  [m/min]	Cutting capacity  [mm]	Cutting width  [mm]	Weight  [kg]	Inner hose diameter  [mm]	Dimension a x b x c  [mm]	Air consumption average  [l/min]	Air inlet  [inch]	Duty level  2	Noise LpA  [dB(A)]	Vibration  [m/s <sup>2</sup> ]
RC6220	--	--	--	0.65	8	258x116x120	0.5l/cut	1/4" IG	2	65.2	2.97

24 max. pressure 6.3 bar (90 psi) IG: female thread

norms applied : noise according to noise according to ISO15744, vibration 3-axis according to ISO28927-1, more detailed specs see page 69





Cuts in the middle keeping the material on both sides almost untouched - raw material and cut off part both remain in good shape. Cutting width 5 mm at 2 m/min and for thicknesses up to 1,5 mm (normal car body sheet metal and aluminium). Cutting curves possible over 100 mm radius. Model 6212 with cold-insulating composite handle with integrated rubber patches for better grip.

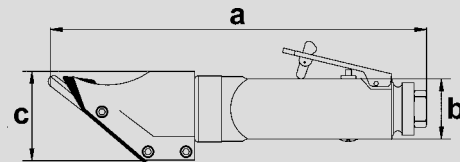

	Model	Article no.
shear	<b>RC6210</b>	8951076009
shear, composite	<b>RC6212</b>	8951076020

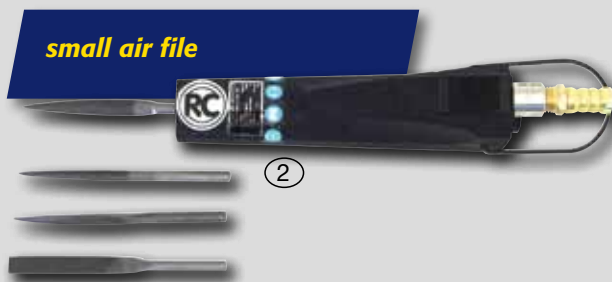

With double piston drive to use for deburring or shapening sheet metal, iron, plastics, deburring. Including file set with 4 different files (flat, half round, round, triangular). Can also be transformed into a finger sander with extra accessory sanding finger length x width = 63x19 mm for use with standard 20 mm abrasive bands (see also finger sander model 6910 on page 37).

	Model	Article no.
file machine	<b>RC6900</b>	8951075000
file set, 4 piece	<b>RC6901</b>	8951011529



Sheet metal nibbler for shaping normal car body material as well as aluminium sheet metal up to 1 mm thickness. Even for cutting of small curves or for enlarging holes - cutting width 4 mm and cutting speed 2,6 m/min. With easy to maintenance piston - regreasing through lid on top. Punch and die plate are exchangeable.



	Model	Article no.
air nibbler	<b>RC6100</b>	8951076008

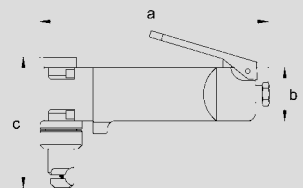

Model	Cutting speed [m/min]	Cutting capacity [mm]	Cutting width [mm]	Weight [kg]	Inner hose diameter [mm]	Dimension a x b x c [mm]	Air consumption average [l/min]	Air inlet [inch]	Duty level %	Noise LpA [dB(A)]	Vibration [m/s <sup>2</sup> ]
RC6100	2.6	1	4	0.65	8	262x38	360 540	1/4" IG	2	91.6	8.55
RC6210	2	1.5	5	0.51	8	265x64x55	360 540	1/4" IG	2	87.2	4.81
RC6212	2	1.5	5	1.20	8	265x40x60	360 540	1/4" IG	2	87.2	4.81

max. pressure 6.3 bar (90 psi) IG: female thread

norms applied : noise according to noise according to ISO15744, vibration 3-axis according to ISO28927-7, more detailed specs see page 69

Model	Tool [mm]	File insert [mm]	Stroke [min <sup>-1</sup> ]	Weight [kg]	Inner hose diameter [mm]	Dimension a x b x c [mm]	Air consumption average [l/min]	Air inlet [inch]	Noise LpA [dB(A)]	Vibration [m/s <sup>2</sup> ]
RC6900	6 / 10x3 / 7x7x7 / 10x3.8	6.5	3700	1.1	8	165x48x28	120 170	1/4" IG	84.5	8.61

max. pressure 6.3 bar (90 psi) IG: female thread

norms applied : noise according to noise according to ISO15744, vibration 3-axis according to ISO28927-7, more detailed specs see page 69

145 mm



②



Mini-Saw, good for working in confined areas, on dash boards and door panels, in the boot, on bumpers and for building in sun roofs. With rubber cover on the handle to insulate against cold. Equipped with a hanger for use with balancers. The tool has a rear exhaust and is delivered with a silencing exhaust hose system (DUS23).

mini saw

Model **RC6040RE** Article no. **8951079041**

**Set RC6068 including:**

- 1 air saw RC6067
- 1,5m silencing exhaust hose system DUS31
- 5 saw blade, fine (32 teeth/inch) 8951011514
- 5 saw blade, medium fine (24 teeth/inch) 8951011515
- 5 saw blade, medium (18 teeth/inch) 8951011520
- 1 swivelling connector DG1
- 1 hex. wrench for changing saw blades
- 1 tool box



easy exchange of blades rear exhaust

②



Fast and handy air saw for sheet metals with insulated handle and exhaust guided to the rear side. Ideally suited for precise cutting of car body parts, profiles and sun roofs. 10 mm stroke.

air saw set

Model **RC6050** Article no. **8951079001**  
**RC6051** **8951179000**

**Set RC6051 including:**

- 1 air saw RC6050
- 5 saw blades, fine (32 teeth/inch) 8951011514
- 5 saw blades, medium fine (24 teeth/inch) 8951011515
- 1 swivelling connector<sup>1</sup> DG1
- 1 mini-oiler G1K
- 2 hex. wrench for changing saw blades and adjusting the stop position bail.
- 1 tool box



**Saw Blades and Files**

For the car body specialist and model workshops we stock saw blades for various materials and hardnesses. Short saw blades for sheet metal as well as long blades for profiles - also files in 4 different forms and file adaptor. See page 59



**Reaction-free Cutting / Plunge-cuts into plain surfaces.**

With the oscillating cutters 6605RE and 6610 from RODCRAFT you can cut without the typical reaction forces into sheet metal and other material. See page 30/31

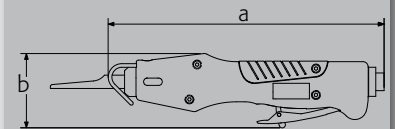

TOP model low vibration and composite



④



low vibration saw set file adaptor 6 mm

Model **RC6067** Article no. **8951079011**  
**RC6068** **8951179020**  
**8951011531**

Elegantly shaped, powerful air saw with composite handle and rear exhaust. (With possibility to connect a silencing exhaust hose system DUS31.)

Very well suited to cut through profiles and multiple-layer sheet metals - also with sealants or glue in between. Using our long

RODCRAFT saw blades larger tubes and profiles can even be cut in one (good for confined areas). The elegant form and its anti-slip-coated handle make this saw perfect to work with in any position. 10000 strokes/min.

When using a file adaptor and files, the tool can also be converted into an air file.

Model	Saw Blades	Stroke	Blows (Speed)	Weight	Inner hose diameter	Dimension a x b x c	Air consumption average	Air inlet	Duty level	Noise LpA	Vibration
	[teeth/inch]	[mm]	[min <sup>-1</sup> ]	[kg]	[mm]	[mm]	[l/min]	[inch]	X	[dB(A)]	[m/s <sup>2</sup> ]
RC6040RE	14/18/24/32	5	5000	0.5	8	145x30	140	1/4" IG	2	74	5.9
RC6050	14/18/24/32	10	9500	0.65	8	262x38	220	1/4" IG	2	79.9	12.57
RC6067 <sup>1</sup>	14/18/24/32	10	10000	0.51	8	265x64x55	150	1/4" IG	4	79.9	6.32

### Fraising Bits

For the precise removal of welding spots without drilling through the "good" side of the sheet metal. Made of very hard cobalt steel HSCo.

Diameter	Model	Article no.
8,0 mm	78F	8951011524



### Set RC6451 consisting of:

- 1 spot weld fraiser RC6450
- 5 fraising bits HSCo 8951011524
- 1 swivel joint DG1
- 1 mini lubricator G1K
- 1 hex. key to exchange fraiser
- 1 tool box



**8 mm fraiser bit  
counter arm swivels  
fraising bit is approached**

Fraiser for precise removal of spot welding points for instance from car body parts. When started, the fraising bit is pushed automatically onto the sheet metal by compressed air and the tool begins to run, removing only the point from one layer of the bonding. The lower layer of sheet metal is not drilled! The fraising depth can be adjusted by 50 micron steps. The delivery includes a 75 mm deep counter arm (swivels and can be removed).

	Model	Article no.
spot weld fraiser	<b>RC6453</b>	8951076013
counter arm 75 mm	6453GH75	8951011525
counter arm 140 mm	6453GH140	8951011526

(fits only this tool, not the other fraisers)

**8 mm fraiser**

Precisely adjustable fraising depth (50 µm) in order not to drill into the remaining sheet metal part. For welding spots, delivered with silencer and fraiser (model 78F see box on left).

	Model	Article no.
spot weld drill	<b>RC6450</b>	8951076012
Set	<b>RC6451</b>	8951176000

Model	Fraiser bit	Speed	Weight	Inner hose diameter	Dimension a x b x c	Air consumption average	Air inlet	Duty level	Noise LpA	Vibration
	[mm]	[rpm]	[kg]	[mm]	[mm]	[l/min]	[inch]	X	[dB(A)]	[m/s²]
RC6450	Ø 8 model 78 F	1800	1.3	8	270x160x33	110 240	1/4" IG	1	78.6	4.17
RC6453	Ø 8 model 78 F	2000	1.15*	8	285x215x75	110 240	1/4" IG	2	88.8	< 2.5

max. pressure 6.3 bar (90 psi), IG: female thread, \*without counter arm

norms applied : noise according to ISO15744, vibration 3-axis according to ISO28927-1, more detailed specs see page 69.

Much less tiring to work with than manual tools. For preparation of up to 1.2 mm sheet metal parts for car body or aluminium before welding. Punch diameter 5 mm for spot welding. Equipped with air-hydraulic multiplier system.

Model **RC6301** Article no. 8951076011

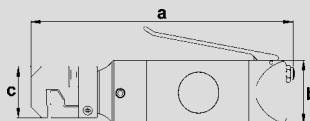

**2 in 1:  
punching and welting tool**

Model	Tool	Speed	Weight	Inner hose diameter	Dimension a x b x c	Air consumption average	Air inlet	Duty level	Noise LpA	Vibration
	[mm]	[rpm]	[kg]	[mm]	[mm]	[l/stroke]	[inch]	X	[dB(A)]	[m/s²]
RC6301	22x12x1.2 / Ø 5 x 1.2	-	1.0	8	245x54	0.8	1/4" IG	2	70.6	3.97

max. pressure 6.3 bar (90 psi) IG: female thread

norms applied : noise according to ISO15744, vibration 3-axis according to ISO28927-1, more detailed specs see page 69.

# Riveters

**up to 5 mm standard (aluminium/copper)  
up to 6,4 mm standard (aluminium/copper)**

Handy blind riveters with collection container for torn-off rivet pins. Durable air-hydraulic force multiplying system and hanger for use with balancers. Model 6700 with 4 different sizes of mouthpieces Model 6710 with swivel air connector, 5 different sizes of mouthpieces and 2 additional sets of extra hardened jaws for replacement in order to allow an optimum adaptation to differently thick rivet pins.



Rivet Size	Model	Article no.
to 5 mm	RC6700	8951074001
to 6,4 mm	RC6710	8951074002



**up to 6,4 mm Standard (steel ...)**

Robust riveter with soft rubber coated handle and easy to maintenance construction. Well suited for an ergonomic work place design with balancer that is attached to the hanger on the tool. With large transparent rivet pin container offering sufficient room for long undisturbed work. With 4 different sizes of mouth pieces and one set of extra hardened jaws for replacement in order to allow an optimum adaptation to differently thick rivet pins.

Model	Article no.
RC6715	8951074003



**6703Xi**  
XTRA INNOVATION

**with pin removal by suction  
up to 4.8 mm steel (standard rivets)  
up to 6.4 mm steel (standard rivets)**

High quality riveters with rivet pin removal by suction (adjustable / can be switched off) and transparent rivet pin collector. Two-finger trigger for easier operation and ON/OFF-switch (for permanently connected tools). Ergonomic due to the large silencer, the cold-insulating handle material and the hanger. Always full stroke and power due to service-friendly hydraulic system. Including 2 additional sets of jaws, 1 additional jaw case, hydraulic oil in a bottle, several keys for adjustment/adaptation, mouthpieces of various sizes, rivet pin extraction tube (only for model 6718Xi).



Rivet Size	Model	Article no.
up to 4,8 mm steel rivets	RC6703Xi	8951074007
up to 6,4 mm steel rivets	RC6718Xi	8951074008

## Spiral Hoses

Our high quality polyurethane spiral hoses with straight ends are excellently suited for use with screwdrivers in combination with our balancers. Due to their low resistance to the pulling force and their small diameter of the spiral they are very practical and comfortable to use. See page 67



## Balancers

In order to design an ergonomic and efficient work place especially the straight screwdrivers often require to be equipped with balancers in combination with spiral hoses with straight ends or with hose balancers. See page 63



### Rivets: BLIND / BULB / BOLT

The most important dimension to select the correct rivet is "A". There are not only standard blind rivets but also high power rivets for high tension (BULB) and high shear resistant (BOLT) that require specially suited riveters.

Also threaded inserts need special riveters to be fixed. Please use the correct drill size when preparing the bores and consider the thickness of the material when selecting the proper rivet length.

#### Standard Blind Rivets

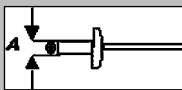

#### BULB-Blind Rivets

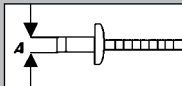

#### BOLT-Blind Rivets

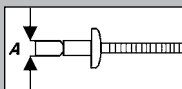

**one tool for 3 types of rivets (standard, BULB, BOLT)  
up to 8.0 mm standard - steel  
up to 6.4 mm standard - stainless steel, steel ...  
6,4 mm special BOLT rivets**

Large versatile riveter with soft rubber coated handle and easy to maintenance construction. Well suited for an ergonomic work place design with balancer that is attached to the hanger on the tool. Equipped with adjustable suction jet and large transparent collection container for torn-off rivet pins. With durable air-hydraulic force multiplying system and swivel air connector. Equipped with 3 different sizes of mouthpieces and one special accessory for 6,4 mm BOLT rivets. Works also on up to 6,4 mm BULB rivets. Including an additional set of hardened jaws.



Rivet Size  
to 8 mm

Model  
**RC6720**

Article no.  
8951074004

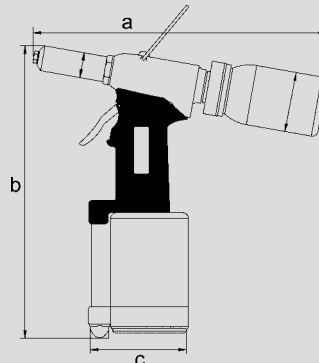

Model	Blind Rivet	Mouthpiece Rivet Pin	Force / Stroke	Weight	Inner hose diameter	Dimension a x b x c	Air consumption average - continuous	Air inlet	Duty level	Noise LpA	Vibration
			<b>F</b>								
	[mm]	[mm]	[N] / [mm]	[kg]	[mm]	[mm]	[l/stroke]	[inch]		[dB(A)]	[m/s <sup>2</sup> ]
RC6700	2.4 - 5.0 *	2.0 / 2.4 3.0 / 3.4	12000	1.6	8	225x280x100	1.2	1/4" IG	2	86.5	3.5
RC6703X	2.4 - 4.8 **	2.4 / 3.2 / 4.0	10900 20	1.5	8	310x287x122	2.1	1/4" IG	3	71	2.3
RC6710	2.4 - 6.4 *	2.0 / 2.4 3.0 / 4.0 / 4.4	19000	2.1	8	255x325x110	1.8	1/4" IG	2	64.1	4.3
RC6715	3.2 - 6.4 **	2.0 / 2.8 3.2 / 4.5	15000	1.8	8	300x300x100	1.1	1/4" IG	3	77.3	2.4
RC6718X	2.4 - 6.4 **	2.0 / 2.4 / 4.3	15200 26	1.9	8	310x316x136	4.3	1/4" IG	3	76.2	2.2
RC6720	4.8 - 6.4 *** 4.8 - 8.0 ** 6.4 "BULB" ** 6.4 "BOLT" **	3.1 / 4.3 / 5.0 4.2 "BOLT"	17000 23	2.6	8	300x310x122	2.0	1/4" IG	3	66.2	3.5

max. pressure 6.3 bar (90 psi).

\* = Cu, Al: only for rivets made of copper, aluminium or softer material.

\*\* = steel: also for rivets made of steel or softer material.

\*\*\* = INOX: also for rivets made of stainless steel or softer material.

"BULB": high tension special rivets (various material).

"BOLT": high shear special rivets (various material)

FT: female thread

norms applied : noise according to ISO15744, vibration 3-axis according to ISO20643, more detailed specs see page 69.

# Autoglass Removal Tools

**oscillating movement**  
20000/min - 0,8 kg



3



Famous, versatile cutter, scraper and saw called "UNICUTTER": especially well suited for removal of windscreens and other glued parts. A silencing exhaust hose system is included in the delivery.

**UniCutter set**

Model Article no.  
**RC6605RE** 8951074005  
**RC6606RE** 8951174000



4

**Set RC6606RE** consisting of:

1 UniCutter with silencing exhaust hose system	RC6605RE
1 blade U24	8951010177 (VE2)
1 blade G35-25	8951010207 (VE2)
2 keys to exchange cutting accessory	
1 tool box	

e.g. for disassemblies from outside / from inside

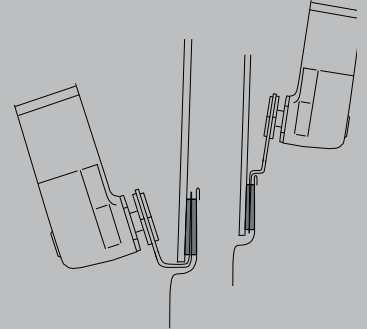

For all RODCRAFT UNICUTTERS we are offering a wide range of accessory with blades for the disassembly of windscreens, with oscillating saw blades for reaction-free cutting (plunge cuts) through plain sheet metal surfaces or other material, with scraper blades for removal of residues of glue etc., e.g. after the disassembly of autoglass etc...

Please see page 31

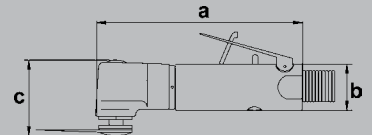

**oscillating movement**  
20000/min - 1,3 kg



3



Large version of model 6605, eg for truck and bus windscreens and other glued autoglass (without silencing exhaust hose system)

**UniCutter, large**

Model Article no.  
**RC6610** 8951074000

## manual glass removal



Autoglass kit AGS185 with square wire for removal of windscreens and rear windows etc. Dimension of wire material AGD186 0,6 x 0,6 mm. Includes an angled manual blade with extra pull handle on short cable. Delivered with wire handles, punch, clip remover level and trim lifting claw.

Set Model Article no.  
Wire, 50 m **AGS185** 8951089055  
**AGD186** 8951011085

## suction cup max. 40 kg

Single suction cup especially suited for working in confined areas. Can be used on glass, boards, sheet metal.



115 mm

**single suction cup**

Model Article no.  
**STS70K** 8951089056

## double suction cup max. 80 kg

Two double suction cups for transport, assembly and disassembly of car windscreens, rear windows etc. Self-adapting to the 3 dimensional shape of the glass - ratchet strap for fixation of the windscreen for additional safety.







115 mm

**set**  
5 m strap with ratchet  
set lever / 2 pins  
spare rubber

Model Article no.  
**STS71K** 8951011087  
**STS71G** 8951011088  
**STS71H** 8951011089  
**STS71SG** 8951011090

Model	Head Interface	Blade Interface	Oscillations	Weight	Dinner Hose Diameter	Dimension a x b x c	Air Consumption average - continuous	Air Inlet	Duty Level	Noise	Vibration
RC6605RE	s [mm]	e [mm]	[min <sup>-1</sup> ]	[kg]	[mm]	[mm]	[l/min]	[inch]	x	[dB(A)]	[m/s <sup>2</sup> ]
RC6610	s = 19 e = 21.9	e = 22	20000	0.8	8	180x40x67	370 530	1/4" IG	3	79.8	5.37
				1.3	8	210x38x82	500 800	1/4" IG	3	86.9	5.38

	Cutting Edge Length [mm]	Speciality	Model (of pack)	Article no. (of pack)	Amount in Pack
<b>U-shape (e.g. for disassembly of windscreens from outside)</b>					
	15		U 15	8951010170	2
	16		U 16	8951010171	2
	17		U 17	8951010172	2
	18		U 18	8951010173	2
	18		U 42-18	8951010189	2
	19		U 19	8951010174	2
	20		U 20	8951010175	2
	22		U 22	8951010176	2
	24		U 24	8951010177	2
	25		U 25	8951010178	2
	25	serrated	U 25-Z	8951010180	2
	26		U 26	8951010179	2
	28		U 28	8951010181	2
	30	long shaft	U 42-30	8951010188	2
	32		U 32	8951010183	2
	36		U 36	8951010184	2
	40		U 40	8951010185	2
	40	serrated	U 40 Z	8951010186	2
	42		U 42	8951010187	2
	45		U 45	8951010190	2
52		U 52	8951010192	2	
60		U 60	8951010193	2	
63		U 63	8951010194	2	
90		U 90	8951010195	1	
100		U 100	8951010196	1	
<b>Straight version without offset</b>					
	16 / 90		G 90-16	8951010253	2
	24 / 90		G 90-24	8951010254	2
	25 / 35		G 35-25	8951010207	2
	25 / 35		G 35-25 Z	8951010209	2
	35 / 90		G 90-35	8951010255	2
	35 / 110		G 110-35	8951010261	2
	50 / 80		G 80-50	8951010251	2
	58 / 90		G 90-58	8951010256	2
	60 / 100		G 100-60	8951010259	2
	70 / 90		G 90-70	8951010258	2
<b>Round angled "┘" sharpened also in angle area</b>					
	25	( 45°	G 100-70	8951010260	2
	35	( 45°	G 35-25 R	8951010208	2
	18	80°	G60-35-45	8951010249	2
	18	80° serrated	H 39 -18 Z	8951010216	2
	24	80°	H 39-18	8951010215	2
	24	80° serrated	H 39-24Z	8951010218	2
	24	( 90°	H 39-24	8951010217	2
	28	80°	G60-24-90	8951010248	2
	30	80°	H 39-28	8951010220	2
	38	80°	H 39-30	8951010219	2
	38	80°	H 39-38	8951010221	2
	38	80° serrated	H 39-38 Z	8951010222	2
	60	90°	H 90-60	8951010257	2
	<b>Scraper e.g. for removal of residual glue</b>				
	10		SC 22-10	8955510008	2

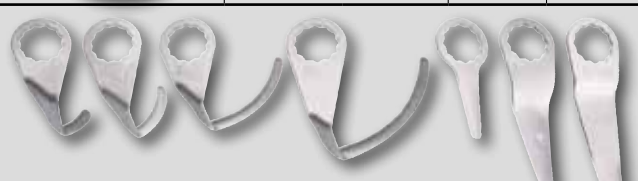
	Cutting Edge Length [mm]	Speciality	Model (of pack)	Article no. (of pack)	Amount in Pack
<b>Straight version with offset (works as robust limit for cutting depth)</b>					
	15		G 57 - 15	8951010223	2
	16		G 57 - 16	8951010225	2
	17		G 57 - 17	8951010224	2
	18		G 57 - 18	8951010229	2
	19		G 57 - 19	8951010226	2
	20		G 57 - 20	8951010230	2
	22		G 57 - 22	8951010231	2
	24		G 57 - 24	8951010232	2
	25		G 57 - 25	8951010233	2
	26		G 57 - 26	8951010236	2
	27		G 57 - 27	8951010234	2
	28		G 57 - 28	8951010237	2
	30		G 35 -25G	8951010210	2
	30		G 57 - 30	8951010238	2
	32		G 57 - 32	8951010235	2
	35		G 57 - 35	8951010240	2
	38		G 57 - 38	8951010241	2
	40		G 57 - 40	8951010239	2
	49		G 57	8951010227	2
	49		G 57-Z	8951010228	2
55		G 57 - 55	8951010242	2	
63		G 57 - 63	8951010244	2	
68		G 57 - 68	8951010245	2	
<b>For difficult to reach areas:</b>					
	24	2 x 45°	G 45 - 24	8951010211	2
<b>Curved Blades</b>					
	45		K30 E	8951010197	2
	45	serrated	K30 E-Z	8951010198	2
	15		K30-15	8951010199	2
	16		K30-16	8951010200	2
	18		K30-18	8951010201	2
	19		K30-19	8951010202	2
	20		K30-20	8951010203	2
	22		K30-22	8951010204	2
	25		K30-25	8951010205	2
	27		K30-27	8951010206	2
<b>Saw Blades / Depth Control</b>					
	160 Z	63x0,5 mm	S63 PB	8951010247	1
	200 Z	80x0,5 mm	S80 PB	8951010252	1
	To control cutting depth		SS63/80	8951010246	1
					
Starter Kit with Bestseller Blades U24, U36, U63, U90, G35-25, G57, G90-58			UG - Set	8951010214	7
Opel/Vauxhall-Tigra: G45-24, G60-24, G80-50			O 80 - TI	8951010212	3
Opel/Vauxhall-Astra B: G57-17,G57-63,G57-68,H57-24,H57-28,H57-38			Astra B	8951010213	6

# Mini Die Grinder 20000 - 55000 rpm

rear exhaust  
55000 rpm. 3 mm



②



High-speed precision grinder - pencil style - for engravings or tuning work. Includes collet 3 mm. The supplied silencing exhaust hose system guides air flow away from the use.

mini die grinder 3 mm collet 3 mm  
Model **RC7050RE** Article no. *8951075190*  
Model **SPZE3** Article no. *8951011483*



## Carborundum Grinding Points

Sets with 5 different shapes: ball, cone, bullet and long and short cylinder. Available with 3 and 6 mm collet shafts.

Set	Model	Article no.
5 x 3 mm	<b>K03</b>	<i>8951011573</i>
5 x 6 mm	<b>K06</b>	<i>8951011574</i>



rear exhaust  
25000 rpm. 6 mm (3 mm)



②



Mini die grinder with 6 mm collet (3 mm collet also available). With rear exhaust in order to attach a silencing exhaust hose system. Long design available for two hand use and difficult to reach spots.

die grinder short  
die grinder long  
collet 6 mm  
collet 3 mm

Model	Article no.
<b>RC7010</b>	<i>8951075040</i>
<b>RC7045</b>	<i>8951075120</i>
<b>SPZA6</b>	<i>8951011480</i>
<b>SPZA3</b>	<i>8951011460</i>

rear exhaust  
26000 rpm. 6 mm (3 mm)



②



Small die grinder with insulated handle and 6 mm collet (3 mm collet also available). With integrated rear exhaust and adapter ring to attach a silencing exhaust hose system (DUS 23).

die grinder 6 mm set  
collet 6 mm  
collet 3 mm  
Model **RC7011** Article no. *8951075050*  
Model **RC7012** Article no. *8951175000*  
Model **SPZA6** Article no. *8951011480*  
Model **SPZA3** Article no. *8951011460*

Set **RC7012** consists of:

- 1 die grinder 6 mm
- 5 grinding points with 6 mm shaft
- 5 grinding points with 3 mm shaft
- 1 collet 3 mm
- 2 key for exchange of accessories
- 1 tool box

**RC7011**  
*8951011574*  
*8951011573*  
*8951011460*



silencing exhaust hose systems see page 67

Model	Collet	Power	Speed	Weight	Inner Hose Diameter	Dimension a x b x c	Air Consumption average - continuous	Air Inlet	Duty Level	Noise LpA	Vibration
	 [mm]	 [W]	 [rpm]	 [kg]	 [mm]	 [mm]	 [l/min]	 [inch]	 X	 [dB(A)]	 [m/s <sup>2</sup> ]
RC7050RE	3	150	55000	0.2	8	134x15	140 180	1/4" IG	2	75.2	2.6
RC7010	6	280	25000	0.4	8	154x40x20	320 390	1/4" IG	2	82.4	3.6
RC7011	6	300	26000	0.4	8	155x38x19	340 415	1/4" IG	2	82.7	9.54
RC7045	6	300	23000	0.55	8	233x34x20	330 400	1/4" IG	2	83.9	3.3



**rear exhaust  
20000 rpm. 6 mm (3 mm)**



②



Famous tool with 6 mm collet.  
With easy to control handle form  
for which a silencing exhaust hose system is  
available.

**die grinder 6 mm  
set**

collet 6 mm  
collet 3 mm

Model	Article no.
<b>RC7020</b>	8951075080
<b>RC7021</b>	8951175010
<b>SPZA6</b>	8951011480
<b>SPZA3</b>	8951011460

**composite - insulated  
6 mm  
rear exhaust**



②



Ergonomic handle with good grip due to integrated rubber patches and a lever that vanishes by sinking snugly into housing. With 6 mm precision collet and high grinding speed (3 mm collets available as accessory).

This tool can be equipped with a silencing exhaust hose assembly (DUS21) which keeps cold air, oil and noise away from the user.

**die grinder 6 mm**

collet 6 mm  
collet 3 mm

Model	Article no.
<b>RC7027</b>	8951075330
<b>SPZA6</b>	8951011480
<b>SPZA3</b>	8951011460



Set RC7021 consists of:

- 1 die grinder 6 mm
- 5 grinding points with 6 mm shaft
- 5 grinding points with 3 mm shaft
- 1 collet 3 mm
- 2 keys for exchange of accessory
- 1 tool box

<b>RC7020</b>	8951011574
	8951011573
	8951011460

**700 W  
6 mm / 8 mm collet  
silencing exhaust hose system**



③



All die grinders versions – collets 6 mm / 8 mm - short construction / long for two handed operation or for work in cylinders, tubes or at difficult to reach spots.

All die grinders of this type are equipped with a silencing exhaust hose system.

- short die grinder 6 mm**
- short die grinder 8 mm**
- long die grinder 6 mm**
- long die grinder 8 mm**
- collet 6 mm
- collet 8 mm

Model	Article no.
<b>RC7025RE</b>	8951075130
<b>RC7026RE</b>	8951075150
<b>RC7060RE</b>	8951075210
<b>RC7065RE</b>	8951075230
<b>SPZD6</b>	8951011482
<b>SPZD8</b>	8951011485

**700 W  
6 mm collet  
exhaust downwards**

②

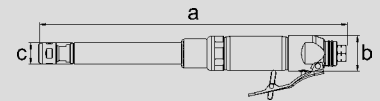

Long type large die grinder with 6 mm collet and downward exhaust (mid tool sideways). This design allows two handed working styles for rough grinding applications.

**die grinder 6 mm  
collet 6 mm**

Model	Article no.
<b>RC7080</b>	8951075160
<b>SPZA6</b>	8951011480

Model	Collet  [mm]	Power  [W]	Speed  [rpm]	Weight  [kg]	Inner Hose Diameter  [mm]	Dimension a x b x c  [mm]	Air Consumption average - continuous  [l/min]	Air Inlet  [inch]	Duty Level  x	Noise  LpA [dB(A)]	Vibration  [m/s <sup>2</sup> ]
RC7020*	6	400	20000	0.70	8	175x40x20	410 520	1/4" IG	2	83.4	3.59
RC7025RE	6	700	22000	1.00	8	184x40x20	490 600	1/4" IG	3	77.9	2.9
RC7026RE	8	700	22000	1.00	8	184x40x20	490 600	1/4" IG	3	77.9	2.9
RC7027*	6	400	20000	0.60	8	175x40x20	410 520	1/4" IG	3	83.4	3.59
RC7060RE	6	700	18000	1.20	8	340x43x35	490 600	1/4" IG	3	73.7	3.11
RC7065RE	8	700	18000	1.20	8	340x43x35	490 600	1/4" IG	3	73.7	3.61
RC7080	6	700	18000	2.00	8	438x53x30	510 680	1/4" IG	2	84.9	2.38

max. pressure 6.3 bar (90 psi) FT: female thread

norms applied : noise according to ISO15744, vibration 3-axis according to ISO20643 (\*: ISO 28927-13), more detailed specs see page 69.

# Tyre Buffers, Wheel Grinders Erasers

special buffing tools for tyres / cutters

- fast speed (to cut steel wires and spot grinding for damage repair)
- powerful (cold grinding e.g. of rubber, moulding)



Easy to control handle form with durable air motor. With slow running powerful planetary gear or alternatively fast direct drive. Special version 7078RE for high radial forces (with extra heavy duty front bearing). All "RE" models are equipped with a silencing exhaust hose system that takes away the cold air - avoids also that rubber dust is distributed, no lubricants from the compressed air get onto the cleanly buffed surface that should be ready for vulcanisation. Model 7079RE like model 7078RE but with cold-insulating composite handle with anti-slip rubber patches. All hex chucks 11 mm are quick change chucks with threaded adapter 3/8"-24.

Speed	Collet Chuck Size	Model	Article no.
19000 rpm	collet 6 mm	<b>RC7020</b>	8951075080
	drill chuck, key-less 10 mm	<b>RC7072RE</b>	8951075270
3400 rpm	collet 6 mm	<b>RC7040</b>	8951075110
	drill chuck, key-less 10 mm	<b>RC7077RE</b>	8951075310
	hexagonal chuck 11 mm	<b>RC7075RE</b>	8951075290
	like 7075RE but for heavy duty	<b>RC7078RE</b>	8951075320
	like 7078RE but composite	<b>RC7079RE</b>	8951074009
	collet 6 mm	<b>SPZA6</b>	8951011480
	drill chuck, key-less 10 mm		8951011458
	hexagonal chuck 11 mm		8951011463

3400 rpm.  
for large 6 mm wheel accessories



2

Powerful 400 W die grinder with 6 mm collet for grinding wheels and flap wheels e.g. with "surface conditioning material - scm", clamping spindles, etc. (delivery does not include abrasives - Please check for max. speed of the abrasive before using with grinder)



die grinder 3400 rpm  
collet 6 mm

Model Article no.  
**RC7040** 8951075110  
8951011480

adhesives, decals, vinyl  
erasing, zapping



2

Efficient tool for renovation of painted surfaces with a slim eraser wheel - more types of eraser wheels available as accessory. No danger for the painted surface - please follow the instruction manual strictly (clean and dust-free, do not press). Low speed erasing due to the powerful planetary gear avoids heating up. A silencing exhaust hose assembly (DUS 21) can be attached. **Model 7037:** Ergonomic handle with good grip due to integrated rubber patches and a lever that sinks plainly into the housing.



RC7035

insulating composite handle

3



Eraser, aluminium body  
Eraser, composite body

**RC7035** 8951075100  
**RC7037** 8951075340

For cold efficient erasing see also our ergonomic models 7091 on page 36.

Model	Collet [mm]	Power [W]	Speed [Rpm]	Weight [kg]	Inner Hose Diameter [mm]	Dimension a x b x c [mm]	Air Consumption average - continuous [l/min]	Air Inlet [inch]	Duty Level (X)	Noise LpA [dB(A)]	Vibration [m/s <sup>2</sup> ]
RC7020	6	400	20000	0.70	8	175x40x20	410 520	1/4" IG	2	83.4	3.59
RC7035	3/8"-24 AG 5/16" IG	400	2600	0.90	8	230x44x16	420 500	1/4" IG	2	82.3	4.5
RC7037	3/8"-24 AG 5/16" IG	400	2600	0.90	8	230x44x16	420 500	1/4" IG	3	82.3	4.5
RC7040	6	400	3400	0.90	8	215x44x21	410 500	1/4" IG	2	79.9	4.78
RC7072RE	10	400	19000	0.65	8	232x40x44	410 520	1/4" IG	2	74.8	3.04
RC7075RE	11	400	3400	0.80	8	209x40x32	410 520	1/4" IG	2	74.1	5.58
RC7077RE	10	400	3400	0.80	8	232x40x44	410 520	1/4" IG	2	74	5.32
RC7078RE	11	400	3400	0.90	8	209x40x32	410 520	1/4" IG	3	73.5	5.07
RC7079RE	11	400	3400	0.95	8	255x40x32	410 520	1/4" IG	3	73,5	5.07

### Sanding belts

High-quality abrasive belts with zirconia alumina / aluminium oxide for high efficiency and durability. Suited for all metals. Less discolouration due to cold abrasion thanks to many additives. With high edge stiffness.

Please see also page 60



### Hexagonal Chuck 11 mm

Automatically centering chuck / adapter for extremely high power without slipping. Accessories and grinding wheels e.g. for tyre buffing can be quickly exchanged. Including an adapter for the use of drill chucks 3/8"-24.



description Article no.  
Hexagonal chuck 11mm 8951011463

### Eraser Wheels and Adapters:

slim and solid eraser wheel design for corners and profiles "cool erasing" broad wheel with airy lamellae structure for efficient cool working on surfaces (no damage of the painted surface – please follow the instruction manual strictly)

### Eraser Wheel

description Article no.  
1 slim eraser wheel with thread 5/16" male 8951011677

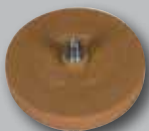

5 broad eraser wheels + flange / thread 5/16" male 8951012289



1 broad eraser wheel + flange / thread 5/16" male 8951012291



Adapter for slim eraser wheel For use with 6 mm collets and chucks 8951011678

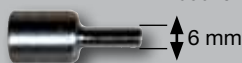

### 10 mm belts



Small belt sander with three heavy duty belts especially for confined areas. The fast-tensioning mechanism allows the exchange of sanding belts by one hand. For a most ergonomic working position the handle can be adjusted in its angle towards the belt.

### 10 mm belt sander

Model Article no.  
**RC7155** 8951072041

sanding belt 10x330mm grain 40 8951011604  
sanding belt 10x330mm grain 80 8951011570  
sanding belt 10x330mm grain 120 8951011577  
sanding belt 10x330mm grain 180 8951011578  
sanding belt 10x330mm grain 240 8951011579

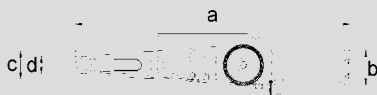

### 20 mm belts



The tool can be used 100% into corners since the arm does not disturb on the side of the belt.

The fast-tensioning mechanism allows the exchange of sanding belts by one hand. For a most ergonomic working position the handle can be adjusted in its angle towards the belt. Continuous work is made more comfortable due to a broad resting plate for the second hand.

### 20 x 520 mm belt sander, long

Model Article no.  
**RC7156** 8951072051

sanding belt 20x520mm grain 80 8951011580  
sanding belt 20x520mm grain 120 8951011581  
sanding belt 20x520mm grain 180 8951011582  
sanding belt 20x520mm grain 240 8951011583

### 30 mm belts



Large belt sander with removable side handle. The fast-tensioning mechanism allows the exchange of sanding belts by one hand. The delivery includes two sanding belts. For a most ergonomic working position the handle can be adjusted in its angle towards the belt.

### 30 x 540 mm belt sander, long

Model Article no.  
**RC7157** 8951072061

sanding belt 30x540mm grain 80 8951011592  
sanding belt 30x540mm grain 120 8951011593  
sanding belt 30x540mm grain 180 8951011594  
sanding belt 30x540mm grain 240 8951011595

Model	Width of Abrasives [mm]	Min. Length of Piece of Abrasive [mm]	Speed [Rpm]	Weight [kg]	Inner Hose Diameter [mm]	Dimension a x b x c x d [mm]	Air Consumption average - continuous [l/min]	Air Inlet [inch]	Duty Level	Noise LpA [dB(A)]	Vibration [m/s <sup>2</sup> ]
RC7155	10	330	18000	0.8	8	285x37x22	400 520	1/4" IG	2	79.5	2.5
RC7156	20	520	17000	1.15	8	353x44x35x22	400 520	1/4" IG	2	83.2	2.4
RC7157	30	540	13000	2.2	8	420x78x45	530 660	1/4" IG	2	91.6	4.6

# Rodcraft MBX Removal System

## RODCRAFT MBX –

A patented system with tool and accessory program. With and without sand blasting effect (without sand) for removing rust, under body coating, paint, sealants and various types of stickers, decals, trim lines or vinyl adhesives.

We offer you the choice of a large range of accessory:

- special brush belts with and without sand blasting effect for removing rust, paint and even under body coatings. Made of polyamid textile belts with wires (sewn into the textile in pairs) with qualites ranging from (straight and angled, 0.5 - 0.7 mm thickness, tip-hardened spring steel or anti-corrosion effect stainless steel).
- lamellae eraser wheels for cold and smooth removal of stickers and decals preventing smearing (heating up the glue) and naturally without damaging the painted surface.
- adapter wheels for the abrasive and non-abrasive accessory, widths 11 and 23 mm.

### RODCRAFT MBX Removal Kit - AUTOMOTIVE REPAIR



Complete starter set with air tool, 2 adapter wheels (widths 11, 23 mm) and accessory for the removal of:

- under body coatings and sealants with the black brush belts BU002 - 11 mm and 23 mm (with sand blasting effect, without sand, can be resharpened)
- rust and oxides with the ocre brush belt 11 mm (with sand blasting effect, without sand, can be resharpened)
- paint with the green brush belt 11 mm
- stickers, decals and trim lines with the lamellae eraser wheel 23 mm

kit for automotive repair      Model      Article no.  
**RC7091**      **8951176010**

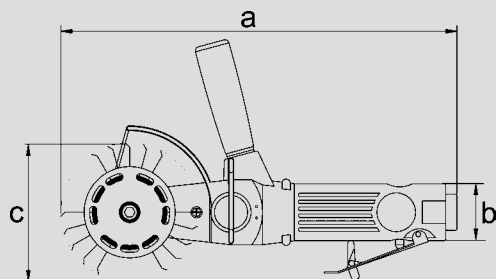

coarse



removing:  
under body coating, sealants as well as thick paint.  
With very coarse sand blasting effect!

medium



removing:  
rust and oxides with fine sand blasting effect.  
Works also in corners and confined areas.

fine



removing:  
paint, coatings (eg sealants) and rust  
without sand blasting effect!

special fine



removing:  
paint and corrosion.  
For working on aluminium car bodies and non-ferrous metal parts.  
With and without sand blasting effect!

erasing



cold removing:  
Vinyls, decals, trims, stickers without  
damaging the paint surface - no heating up!

Model	System	Power	Speed	Weight	Inner Hose Diameter	Dimension a x b x c	Air Consumption average – continuous	Air Inlet	Duty Level	Noise LpA	Vibration
RC7091	MBX	420	3500	1.10	8	275x95x40	110 670	1/4" IG	3	83.2	< 2.5

**Width**

**23 mm**

Model (Article no.)

**11 mm**

(Especially for difficult to reach spots, like 90° angles.)

Model (Article no.)

black



**BU015-5 (8951011663)**

VE5\*  
angled, sharpened,  
hardened tip, sand blasting  
effect without sand  
Ø 0,7 mm thick spring steel  
lifetime can be multiplied  
by resharpening

**BU020-5 (8951011664)**

VE5\*  
angled, sharpened,  
hardened tip, sand blasting  
effect without sand  
Ø 0,7 mm thick spring steel  
lifetime can be multiplied  
by resharpening

Removal of under body coatings and sealants, stripping paint. Very well suited for welding seam areas, contours and corners - with sand blasting effect.



ochre



**BU022-5 (8951011665)**

VE5\*  
angled, sharpened,  
hardened tip, sand blasting  
effect without sand  
Ø 0,5 mm thick spring steel  
lifetime can be multiplied  
by resharpening

**BU021-5 (8951011666)**

VE5\*  
angled, sharpened,  
hardened tip, sand blasting  
effect without sand  
Ø 0,5 mm thick spring steel  
lifetime can be multiplied  
by resharpening

High efficiency rust removal brush belts, cleaning even porous surfaces and on difficult to reach spots, like 90° corners.



green



**BU017-5 (8951011667)**

straight  
hardened tip  
Ø 0,5 mm thick spring  
steel

**BU028-5 (8951011668)**

VE5\*  
straight  
hardened tip  
Ø 0,5 mm thick spring steel

Rust removal and cleaning, taking gaskets away from casted iron but not suited for aluminium sheet metal or casted aluminium! Without sand blasting effect.

11 mm version strips paint even in contoured areas, in corners and removes protective coatings from sheet metals before welding them e.g. into the car body.



blue



**BU018-5 (8951011671)**

VE5\*  
straight  
Ø 0,5 mm stainless steel

**BU031-5 (8951011672)**

VE5\*  
straight  
Ø 0,5 mm stainless steel

Stripping paint and corrosion from aluminium parts (car, truck or bus body). Very versatile and selective the brush belt does not remove structures like rivet heads, screws etc. and can be used easily on contours. With or without sand blasting effect.



**BU019-5 (8951011669)**

VE5\*  
angled  
sand blasting effect  
Ø 0,5 mm stainless steel

**BU030-5 (8951011670)**

VE5\*  
angled  
sand blasting effect  
Ø 0,5 mm stainless steel

Stripping paint and corrosion from aluminium parts (car, truck or bus body). Very versatile and selective the brush belt does not remove structures like rivet heads, screws etc. and can be used easily on contours. With or without sand blasting effect.



caramel



**ZU014 (8951011649)** VE5\*

**ZU010 (8951011652)** VE1\*



**MBX Eraser Wheel (23 mm)**

Removal of vinyl, glue, stickers, decals, trim lines, double sided adhesive tape from painted sheet metal, fibreglass, glass, wood, aluminium. Not good for use on polyethylene, polypropylene, acryl, plexiglass. The manufacturer cannot be held liable for use on any of these materials - if in doubt test on specimen first.

**Rodcraft MBX accessory**

<b>ZU002</b>	work place rack, black	<b>8951011650</b>
<b>ZU003</b>	stone for resharpening, for all angled MBX brush belts	<b>8951011651</b>
<b>AS012</b>	adapter 11 mm (for small belts)	<b>8951011648</b>
<b>AS009</b>	adapter 23 mm (for broad belts and eraser)	<b>8951011647</b>



All MBX - brush wires are sewn pairwise and U-shaped into the high-tension polyamid textile belt!  
\*VE = amount included in this pack

# Mini Angle Grinders Pistol Grinder

**6 mm collet  
with silencing exhaust hose  
system**



①



Mini angle grinder with 6 mm collet and 18000 rpm (adjustable). Reduced noise and no disturbing exhausted air due to silencing exhaust hose system. With mini grease plug.

	Model	Article no.
mini angle grinder	<b>RC7100RE</b>	8951075121
collet 6 mm	<b>SPZA6</b>	8951011480
collet 3 mm	<b>SPZA3</b>	8951011460

**105° angle head  
easy to control, for two hands  
cold-insulated handle**



②



Ergonomically optimised mini angle grinder with 15000 rpm adjustable speed. Very handy shape, that can be controlled perfectly especially during two handed operation. With cold-insulated handle and rear exhaust with adapter for use of a silencing exhaust hose system (DUS 23).

	Model	Article no.
mini angle grinder	<b>RC7107</b>	8951075005
set	<b>RC7108</b>	8951175005
collet 6 mm	<b>SPZA6</b>	8951011480
collet 3 mm	<b>SPZA3</b>	8951011460



**Set RC7108 consists of:**

- 1 angle grinder 6 mm **RC7107**
- 5 grinding points with 6 mm shaft **8951011574**
- 5 grinding points with 3 mm shaft **8951011573**
- 1 collet 3 mm **8951011460**
- 2 keys for exchange of accessory
- 1 tool box

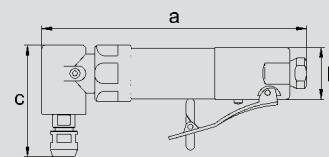

**direct drive pistol  
easy to control with 2 hands  
set for 50 and 75 mm accessory**



③



Pistol tool with excellent price / power ratio (no angle gear). Comfortable to use with silencing exhaust hose system, for extra reduced noise and no disturbing exhausted air.

	Model	Article no.
mini pistol grinder	<b>RC7015RE</b>	8951075111
set	<b>RC7016RE</b>	8951175011
collet 6 mm	<b>SPZA6</b>	8951011480
collet 3 mm	<b>SPZA3</b>	8951011460



**Set RC7016RE consists of:**

- 1 pistol grinder 6 mm **RC7015RE**
- 1 backing pad 6 mm-50 mm (2") Roloc® **8951011631**
- 1 backing pad 6 mm-75 mm (3") Roloc® **8951011632**
- 5 abrasive felt Roloc® 50 mm (2") **8951011557**
- 5 abrasive felt Roloc® 75 mm (3") **8951011558**
- 3 Bristle Discs Roloc® with various grain
- 2 keys for exchange of accessory
- 1 oil bottle
- 1 tool box

**direct drive  
composite  
regulator**



③



For spot repairs - paint repairs limited to a small area, saving time and consumables. Lightweight and handy tool with composite housing. Speed regulator with thumb knob for one hand operation. Air exhaust down motor housing.

	Model	Article no.
set	<b>RC7681K</b>	8951000019



**Set 7681K consists of:**

- 1 pc. mini pistol grinder **RC7681**
- 1 pc. 50 mm (2") Roloc backing pad **8955000005**
- 1 pc. 75 mm (3") Roloc backing pad **8955000004**
- 2 pcs. abrasives (grain 60) in each 50 (2") / 75 mm (3")
- 2 pcs. abrasives (medium-blue) in each 50 (2") / 75 mm (3")
- 2 pcs. abrasives (coarse-brown) in each 50 (2") / 75 mm (3")

Model	Collet	Power	Speed	Weight	Inner Hose Diameter	Dimension a x b x c	Air Consumption average - continuous	Air Inlet	Duty Level	Noise	Vibration
	[mm]	[W]	[Rpm]	[kg]	[mm]	[mm]	[l/min]	[inch]	(X)	LpA [dB(A)]	[m/s²]
RC7015RE	6	300	17000	0.40	8	147x124x40	385 420	1/4" IG	3	85.8	1.46
RC7100RE	6	230	18000	0.40	8	160x33x78	300 390	1/4" IG	1	87.3	5.73
RC7107	6	300	15000	0.55	8	160x37x97	320 390	1/4" IG	2	82	8.3

### Accessory for Pistol Sanders

Backing pads in various hardnesses, adapter for use of standard 5/8" accessory and adapter for drill chuck thread size 3/8"-24. Please see also page 61

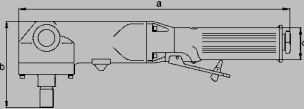
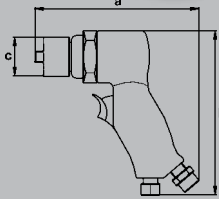

### Sanding with Angle Grinders

Angle sanders can be used with backing pads, fibre discs and flap discs as well as brushes. Diameters of backing pads that fit our RODCRAFT angle tools:

Model 7166 (M14x2)	115 mm 125 mm
Model 7120 (5/8")	178 mm
Model 7121 (M14x2)	178 mm
Model 7181 (M14x2)	178 mm
Model 7183 (5/8")	178 mm

Please see also page 40/41

### Practical accessory that can be attached quickly

For spot repairs, sanding, rust removal, stripping paint. Please see also page 60



for flexible fibre discs up to 115 mm adjustable speed



Fast pistol sanders with adjustable speed (and power) for fibre discs. For safety reasons this tool cannot be used with hard cutting and grinding discs, please see our models 7160 - 7166 with speed governor.

### pistol sander

Model	Article no.
<b>RC7150</b>	8951072021
protective guard for 7150	7150-S 8951011538
backing pad 80 x 22 mm	316-2 8951011544
backing pad 115 x 22 mm	416-2 8951011545
backing pad 140 x 22 mm	516-2 8951011548
adapter with M14 x 2 AG	A7150 8951011449

for flexible fibre discs up to 178 (7") mm cold-insulated with rear exhaust



Ergonomically optimised angle grinder with cold-insulated handle, silencer and rear exhaust. Ideally suited for sanding of metal surfaces and stripping of paint or other coatings. With easy maintenance grease plug for fast regreasing of the angle gear. Additional side handle can be mounted on both sides to serve also left handed persons.

Two type of thread available:  
model 7120 with 5/8" thread and backing pad,  
model 7121 with M14x2 thread for standard M14 accessory

**angle sander with 5/8" backing pad (178 (7") mm)**  
**angle sander with M14x2 thread (without accessory)**  
backing pads for flexible fibre discs 178 (7") mm - 5/8" IG  
lock nut for backing pad 5/8" IG  
two-hole key for lock nut  
backing pad, velcro 150 (6") mm - 5/8" IG  
backing pad, velcro 150 (6")mm - M14X2 IG

Model	Article no.
<b>RC7120</b>	8951072001
<b>RC7121</b>	8951072011
716-2	8951011546 8950250605 8950290097
KT150	8951011554
KT150M14	8951011605



Please order lock nut and two-hole spanner along with any order of the backing pad.

Model	Drive	Power	Speed	Weight	Inner Hose Diameter	Dimension a x b x c x d	Air Consumption average - continuous	Air Inlet	Noise LpA	Vibration	
	Tige Disque [mm]	[W]	[Rpm]	[kg]	[mm]	[mm]	[l/min]	[inch]	[dB(A)]	[m/s <sup>2</sup> ]	
RC7120	5/8" AG	178	500	4500	2.0	8	320x38x100	525 700	1/4" IG	91.4	2.7
RC7121	M14 x 2 AG	178	500	4500	2.0	8	320x38x100	525 700	1/4" IG	81	2.7
RC7150	7/16"- 20 AG	75x22 105x22 115x22	400	18000	1.15	8	152x157x38	410 570	1/4" IG	81	3.2
RC7681K	1/4"- 20UNF AG	50 <sup>v</sup> (2") 75 <sup>v</sup> (3")	150	15000	0.4	8	120x125x42	365 490	1/4" IG	74.6	5.9

max. pressure 6.3 bar (90 psi) V: velcro IG: female thread AG: male thread

norms applied : noise according to ISO15744, vibration 3-axis according to ISO28927-3, more detailed specs see page 69.

# Angle Grinders

**for mini cutting discs  
70 or 76x10 mm  
direct drive**



②

Mini cutting grinder ready equipped with a 75x10x1,5 mm cutting disc and protective guard made of steel. With safety lever and rear exhaust.

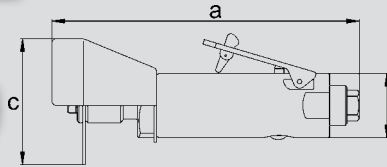

**mini cutting grinder**  
mini cutting discs

Model	Article no.
<b>RC7190</b>	8951075101
70TR	8951011536

**for 115 (4 1/2") and 125mm (5") discs  
for 100mm (4") discs**



②

Very famous and compact type of angle grinder with safety speed governor, protective guard and flanges. The side handle for additional control can be taken off for confined areas. Very versatile for many applications like sanding with flap discs, grinding, cutting. Available for 16 or 22 mm centre hole accessories or pads and brushes with thread e.g. small M14x2 cup brushes and radial brushes as well as backing pads for use of normal and velcro fibre discs up to 125 mm (guard removable). Can be delivered alternatively with two types of thread M10x1,5 and M14x2 two sorts of flanges 16 and 22 mm as well as for three sizes of discs 100x16 mm (4") and 115x22 mm (4 1/2") / 125x22 mm (5"):

**angle grinder M14 x 2**  
**angle grinder M10 x 1,5**  
**angle grinder M10 x 1,5**

for discs 115 (4 1/2")/125(5") x 22 mm  
for discs 115 (4 1/2")/125(5") x 22 mm  
for discs 100 (4")x 16 mm

Model	Article no.
<b>RC7166</b>	8951075051
<b>RC7165</b>	8951075041
<b>RC7160</b>	8951075021

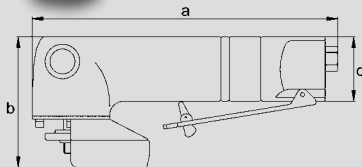

cutting discs  
grinding discs  
cutting discs  
grinding discs

115 (4 1/2")x 22 mm  
115 (4 1/2")x 22 mm  
100 (4")x 16 mm  
100 (4")x 16 mm

115TR	8951011539
115SCH	8951011542
100TR	8951011537
100SCH	8951011540

**for 178 (7") mm discs  
industrial**



③

Robust industrial quality angle grinder with safety speed governor, protective steel guard (can be turned without locking in positions) and flanges. Easy to control grinder with detachable side handle. The typical applications for each type of grinder are:  
For grinding, cutting and flap discs with 22 mm centre hole.  
For threaded abrasives with inner thread M14x2 or 5/8" eg cup brushes or radial brushes, as well as backing pads for velcro and fibre disc use up to 178 mm (guard can be removed)

**angle grinder with flange set 22 mm**  
**angle grinder M14 x 2**  
**angle grinder 5/8"**

for discs 178 (7") x 22 mm  
for discs and M14 x 2 accessory  
for discs and 5/8" accessory

Model	Article no.
<b>RC7180</b>	8951075071
<b>RC7181</b>	8951075081
<b>RC7183</b>	8951075091

cutting discs  
backing pads for flexible fibre discs  
lock nut for backing pad  
two-hole key for lock nut  
velcro pad 150 (6") mm  
velcro pad 150 (6") mm

178 (7") x 22 mm  
178 (7") mm - 5/8" IG (for 7183)  
5/8" IG  
  
5/8"IG  
M14X2 IG

178TR	8951011541
716-2	8951011546
	8950250605
	8950290097
KT150	8951011554
KT150M14	8951011605





for rotating sanders, grinders, cutters

cutting discs

	dimension [mm]	Model	for model	article no.
	75 x 10 x 2	70 TR	RC7190	8951011536
	100 x 16 x 2,4	100 TR	RC7160	8951011537
	115 x 22 x 3	115 TR	RC7165 / RC7166	8951011539
	178 x 22 x 3,4	178 TR	RC7180 / RC7186	8951011541

grinding discs

	100 x 16	100 SCH	RC7160	8951011540
	115 x 22	115 SCH	RC7165 / RC7166	8951011542

backing discs

	75 x 22	316-2	RC7150 / RC7153	8951011544
	105 x 22	416-2	RC7150 / RC7153	8951011545
	125 x 22	516-2	RC7150 / RC7153	8951011548
	170 x 5/8"	716-2*	RC7120 / RC7183	8951011546

lock nut for  
backing pad











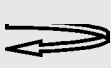

	5/8"		716-2	8950250605
--	------	--	-------	------------

key for lock nut

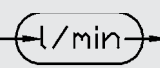
			8950250605	8950290097
--	--	--	------------	------------

\* Please order a lock nut and a nut key along with your orders of backing pads model 716-2 .

Model	Drive	Power	Speed	Weight	Inner Hose Diameter	Dimension a x b x c	Air Consumption average – continuous	Air Inlet	Noise LpA	Vibration
	 Tige  Disque [mm]	 [W]	 [Rpm]	 [kg]	 [mm]	 [mm]	 [l/min]	 [inch]	 [dB(A)]	 [m/s²]
RC7160	M10 x 1.5 AG   100 x 16	750	10000	1.6	8	232x93x47	490 650	1/4" IG	85.2	4.56
RC7165	M10 x 1.5 AG   115x22 125x22	750	10000	1.6	8	232x93x47	490 650	1/4" IG	83.8	8.45
RC7166	M14 x 2.0 AG   115x22 125x22	750	10000	1.6	8	232x93x47	490 650	1/4" IG	85.6	5.69
RC7190	--   70 x 10	350	20000	0.8	8	195x80x40	430 580	1/4" IG	89.5	3.53
RC7180	(5/16" IG)   178x22	700	7600	3.4	8	318x108x58	525 700	3/8" IG	90.8	5.59
RC7181	M14 x 2.0 AG   178x22	700	7600	3.4	8	318x108x58	525 700	3/8" IG	90.2	3.15
RC7183	5/8" AG   178x22	700	7600	3.4	8	318x108x58	525 700	3/8" IG	90.2	3.15

max. pressure 6.3 bar (90 psi) IG: female thread AG: male thread

norms applied : noise according to ISO15744, vibration 3-axis according to ISO28927-1, more detailed specs see page 69.

# Polishers

**with regulator composite**



For Smart repairs – paint repairs limited to a small area, saving time and consumables. Lightweight and handy tool with composite housing. Speed regulator with thumb knob for one hand operation. Air exhaust down motor housing.

model **RC7683K** article no. **8951000017**



article no. **8951011606**

**Set 7683K consists of air tool and:**  
 1 pc. 75 mm (3") velcro pad  
 1 pc. polishing sponge white 75 mm (3")  
 1 pc. polishing sponge yellow 75 mm (3")  
 1 pc. polishing wool pad 75 mm (3")



**flat head ergonomically optimised for confined areas for accessory up to 178 (7") mm**

③

Large angle polisher with special low head design, available with thread type 5/8" and M14x2. Equipped with an insulating handle cover for continuous polishing and rear exhaust to guide away cold exhausted air. The variant with 5/8" thread includes a high quality polishing pad with completely rounded rim and a lamb wool bonnet with straps to tie.

**angle polisher 178 (7") mm – 5/8"**  
**angle polisher 178 (7") mm – M14x2**  
 polishing pad 170 mm – 5/8" (round rim)  
 lamb wool bonnet with straps

model **RC7130** article no. **8951072004**  
**RC7131** article no. **8951072014**  
 article no. **8951011549**  
 article no. **8951011550**

For more polishing accessory range see box on right

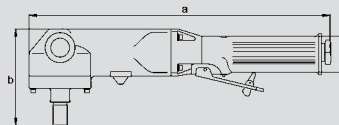

## Polishing Systems

The complete range of polishing accessory can be found on page 61

### 75 mm – velcro - 5/16"

disc **8951011560** + sponge **8951011555**

disc **8951011560** + felt **8951011556**

### 150 mm – velcro – 5/8

disc **8951011554** + sponge **8951011587**

disc (rounded) **8951011554** + lamb wool (velcro) **8951011586**

### 150-170 mm – to tie - 5/8"

disc / sponge **8951011551**









disc (rounded) **8951011549** + lamb wool (to tie) **8951011550**

disc (super soft) **8951011552** + lamb wool (to tie) **8951011550**

Model	Drive		Power [W]	Speed orbital [rpm]	Weight [kg]	Inner Hose Diameter [mm]	Dimension a x b x c [mm]	Air Consumption average – continuous		Air Inlet [Inch]	Noise LpA [dB(A)]	Vibration [m/s <sup>2</sup> ]
	Spindle	Disc [mm]						l/min	l/min			
RC7130	5/8" AG	178	500	2500	2.0	8	320x38x100	525	700	1/4" IG	87.9	6.9
RC7131	M14 x 2 AG	178	500	2500	2.0	8	320x38x100	525	700	1/4" IG	80.8	2.7
RC7683K	5/16" - 24UNF IG	75 (3")	150	5500	0.6	8	125x125x42	360	480	1/4" IG	78.5	3.8

max. pressure 6.3 bar (90 psi) V: velcro sanding pad IG: female thread AG: male thread

42 norms applied : noise according to ISO15744, vibration 3-axis according to ISO28927-3, more detailed specs see page 69.

	model stroke	image	pad diameter.	housing		weight	minimum height	type of suction		page
			[mm]	metal	composite	[kg]	[mm]	port for central dust extraction	self-induced suction	
finishing 2.5 mm orbital stroke	RC7661V		77		X	0,54	120		⊖	44
	RC7682K		75		X	0,53	125		⊖	44
	RC7702V6		150		X	0,70	107	29 / 27	-	45
universal sanding 5 mm orbital stroke	RC7200V		150	X		1,95	165		⊖	46
	RC7805V62H		150		X	0,97	107	29 / 27	-	46
	RC7705V6		150		X	0,73	107	29 / 27	-	45
	RC7691V		200	X		1,76	120	29	-	46
coarse sanding 8 or 10 mm orbital stroke	RC7810V62H		150		X	1,07	107	29 / 27	-	46
	RC7710V6		150		X	0,83	107	29 / 27	-	45

- good for central dust extraction

⊖not equipped for dust extraction

self-induced suction produced by exhaust air

• self-induced suction produced by powerful compressed air

•/- can be switched on/off

# Spot Repair Sanders

## with regulator composite

For Smart repairs  
 – paint repairs limited to a small area,  
 saving time and consumables.  
 Lightweight and handy tool with composite housing.  
 Speed regulator with thumb knob for one hand operation.  
 Air exhaust down motor housing.

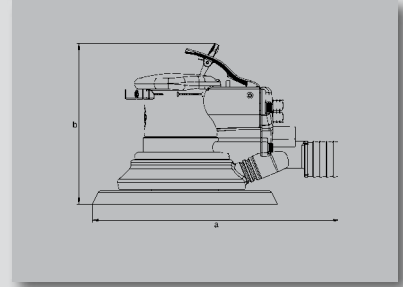

sander kit :

- 1 pc. 50 mm (2") sanding velcro pad
- 1 pc. 75 mm (3") sanding velcro pad
- 10 pcs. abrasives (grain 600) in each 50 (2") / 75 mm (3")
- 10 pcs. abrasives (grain 320) in each 50 (2") / 75 mm (3")
- 10 pcs. abrasives (grain 180) in each 50 (2") / 75 mm (3")

model **RC7682K** article no. **8951000018**

**8955000007**  
**8955000006**



## random orbital sander spot-repair













③ composite

Spot-Repair orbital sander with 2,5 mm stroke and small pad. Ideal for spot repairs (dust enclosures, irregularities or on very rounded surfaces). Comfortably rounded shape with insulating rubber cover and speed regulator.

### spot repair sander, composite

- 77 mm velcro pad – 5/16"
- 77 mm Expert's pad velcro (super soft) – 5/16"
- 75 (3") mm velcro pad – 5/16"

model **RC7661V** article no. **8951072231**  
**8951012259**  
**8951011644**  
**8951011560**

Model	Disc Thread Size	Stroke	Speed orbital	Weight	Inner Hose Diameter	Dimension a x b x c	Air Consumption average – continuous	Air Inlet	Duty Level	Noise LpA	Vibration
	 [mm]	 [mm]	 [Rpm]	 [kg]	 [mm]	 [mm]	 [l/min]	 [Inch]	 3	 [dB(A)]	 [m/s <sup>2</sup> ]
RC7661V	77 <sup>V</sup> - 5/16"	2.5	13000	0.54	8	120x92	500 620	1/4" IG	3	88.0	7.5
RC7682K	75 <sup>V</sup> (3") - 5/16"	5	15000	0.53	8	125x125x42	380 510	1/4" IG	3	79.6	8.9

## Power and Comfort

④



The new RODCRAFT series of palm sanders with ergonomic handle and innovative adjustable exhaust. We offer you the choice of 3 versatile models with 3 different strokes:

- 2,5 mm stroke for finishing and paint repair
- 5 mm stroke versatile for general sanding applications
- 10 mm stroke for coarse efficient sanding of filler and old paint

### ERGONOMICALLY DESIGNED

Low profile composite housing with insulating TPR (thermo-plastic rubber) handle surface. Injected for durable bonding to give best grip at low vibration.

### COMFORT

Elegantly designed composite lever

### PRACTICAL

Knob for adjustment of the right speed for the application, easy to reach for usability with one hand

### USER FRIENDLY

The exhaust direction can be changed to avoid uncomfortable air and to allow left and right hand work by choice of the operator.

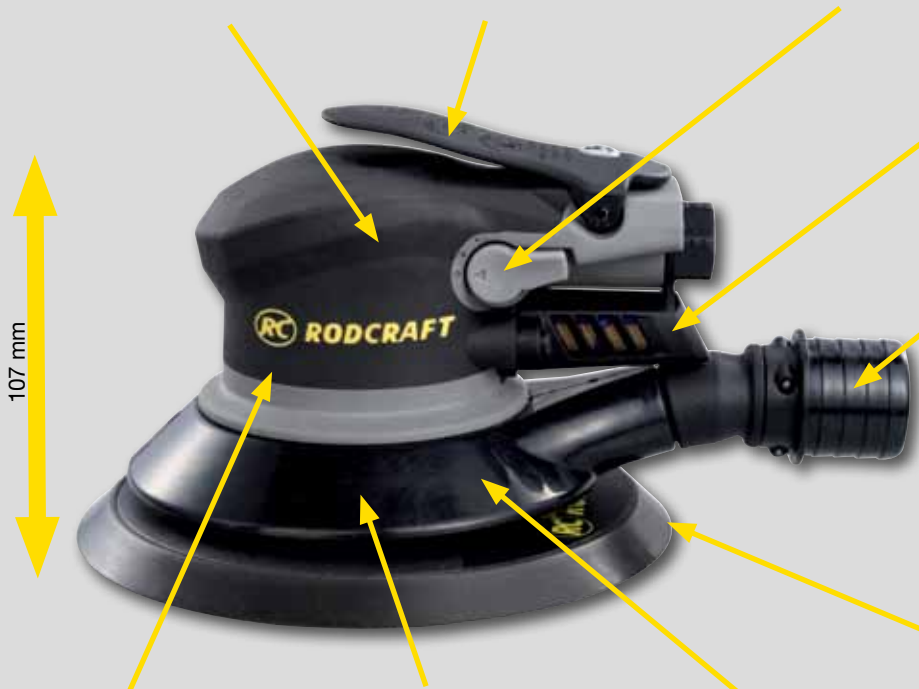

### UNIVERSAL

Sanders are delivered with two interchangeable suction ports with diameters 29 and 27 mm for best connectivity with central dust extraction units.



### POWERFUL

285 W motor with 5 vanes for efficient sanding even with large stroke and coarse grid.

### DURABLE

With high quality bearings and excellent dust protection for continuous sanding

### EFFICIENT

Compact and flexible rubber shroud for efficient dust extraction, not disturbing while good also for large hole patterns when using the RODCRAFT 15 hole pad.

### VERSATILE

15 hole - 150 mm diameter RODCRAFT micro-velcro pad good for all most used abrasive sheets (6 hole, 6+1 hole and 8+1 hole).

**2.5 mm orbital stroke**

**5.0 mm orbital stroke**

**10 mm orbital stroke**

150 mm (6") micro velcro sanding pad 15 hole

model

**RC7702V6**

**RC7705V6**

**RC7710V6**

article no.

8951000021

8951000020

8951000070

8955000012

**2,5 mm**









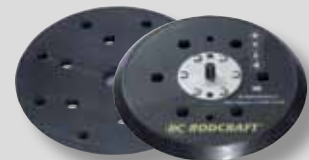

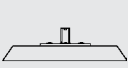

**5 mm**

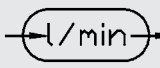

**10 mm**



Model	Disc Thread Size	Stroke	Speed orbital	Weight	Inner Hose Diameter	Dimension a x b x c	Air Consumption average – continuous		Air Inlet	Duty Level	Noise	Vibration
	 [mm]	 [mm]	 [Rpm]	 [kg]	 [mm]	 [mm]	 [l/min]		 [Inch]	 4	 [dB(A)]	 [m/s <sup>2</sup> ]
RC7702V6	150 <sup>V</sup> - 5/16"	2.5	10000	0,70	8	206x107	450	550	1/4" IG	4	79.5	5.4
RC7705V6	150 <sup>V</sup> - 5/16"	5	10000	0,73	8	206x107	450	550	1/4" IG	4	86.1	3.8
RC7710V6	150 <sup>V</sup> - 5/16"	10	10000	0,83	8	206x107	450	550	1/4" IG	4	79.1	9

max. operating pressure 6.3 bar (90 psi) weight without pad (pad approx. 125 g) IG: female thread

norms applied : noise according to ISO15744, vibration 3-axis according to ISO28927-3, more detailed specs see page 69.

# Random Orbital Sanders Geared Orbital Sanders

## simple combi-sander 5 mm random orbital/ rotating sander

Combi-tool for coarse sanding and fishing in one. This two hand sander can be easily switched from – a rotating coarse sander – to – a random orbital sander with 5 mm stroke. Available in two versions: with 150 mm velcro pad or with pad for self-adhering abrasives (without holes)



### 5 mm two hand sander with velcro pad

150 (6") mm velcro pad – 5/16" (RC7200V)  
150 (6") mm pad- 5/16"  
for self-adhering abrasives

model article no..  
**RC7200V** 8951072111

8951011565  
8951011559

## 5 / 10 mm stroke rear exhaust lightweight composite

Elegantly shaped and ergonomic sanders with lightweight composite housing and vibration absorbing long rubber handle Powerful and durable with RODCRAFT high performance motor. The exhaust can\* be piped away from the user innovative new construction, similar to the famous silencing exhaust hose assemblies from RODCRAFT, this can\* keep cold air, noise and dirt away from the surface and the user 2 tool versions for each application, 10 mm and 5 mm stroke. easy to identify for fast selction during the sanding process the lever shows a colour coded marking for the stroke. Suction port swivels, equipped for diameter 29 mm and 27 mm suction hoses. The motor speed can beadjusted from the handle.



two-hand-sanders, 5 mm  
two-hand-sanders, 10 mm  
150 mm (6") micro velcro sanding pad 15 hole

model article no..  
**RC7805V6-2H** 8951000022  
**RC7805V6-2H** 8951000023  
8955000012

## composite lightweight 200 mm (8") pads aggressive with motor driven rotation

200 mm two-hand sanders with powerful 8-vane motor with adjustable speed. Especially suited for sanding of large plain surfaces for instance on buses, wagons etc..

The composite material handle and the motor housing are insulated against the transfer of cold – for long sanding operations.

The sander is equipped with a 29 mm suction port for use with central dust extraction.

Orbital sander + rotation: Sander that simultaneously rotates the pad as well as moving it on an orbit (geared sanders) – typical for aggressive sanding applications.



### 200 mm orbital sander+rotation

200 mm (8") velcro pad, 8hole (on 120 mm), 6 bolts, hard

model article no..  
**RC7691V** 8951072212  
8951012348

Model	Disc Thread Size	Stroke	Speed orbital	Weight	Inner Hose Diameter	Dimension a x b x c	Air Consumption average – continuous		Air Inlet	Duty Level	Noise LpA	Vibration
	[mm]	[mm]	[Rpm]	[kg]	[mm]	[mm]	[l/min]	[l/min]	[Inch]	(x)	[dB(A)]	[m/s <sup>2</sup> ]
RC7200V	150 V - 5/16"	5	10000	1.95	8	260x165x37	315	400	1/4" IG	2	86.6	8.3
RC7691V	200 V - 6xM4	5	10000 (900)	1.76	8	300x120	445	550	1/4" IG	4	88.6	2.8
RC7810V6-2H	150 V - 5/16"	5	10000	0,97	8	315x107	450	550	1/4" IG	4	84.0	5.53
RC7810V6-2H	150 V - 5/16"	10	10000	1,07	8	315x107	450	550	1/4" IG	4	84.0	5.53

**for dust class "L"  
for air tools and electrical tools  
automatic start-stop  
wet-dry**



The dust extraction units comply with class "L" requirements for filters (according to EN 60335-2-69:1999-08).  
For a safer and orderly workshop – the air tools and electrical tools can be attached directly onto the energy supply from the vacuum station – 1 multi-profile compressed air coupler and 1 electricity socket on model 7900 / 2 sockets on model 7910. Automatic On/Off (can be switched to manual) – active as soon as one tool is receiving energy directly from the vacuum station - Automatic stop for vacuum (10 sec delay) after switching off all connected tools.  
The vacuum hose is emptied, avoiding clogs. - Easy remote controlled start of the vacuum system from any connected tool as soon as one of them is started. Equipped for wet and dry applications with integrated sensor.  
**Compact version 7905** with 21 l tank,  
1 motor by-pass cooled, 1 electrical socket, 1 suction hose model 7900/10SC, with nylon bag and class L vleece filtre.

**Large version 7910** with 77 l tank,  
2 motors two-step (operation with one motor possible to save energy) – by-pass cooled, 2 electrical sockets, ready with vacuum diverter for 2 suction hoses, with nylon bag and class "L" vleece filter, basket for accessories or sander and practical joint to tilt the tank for fast and easy emptying for instance into a drain.  
Produces sufficient vacuum to work with 2 sanders simultaneously.  
Two air tools are possible to be operate with compressed air when using an additional air diverter model 7910VD, article no. 8951011130.

<b>21 l small dust extraction system with hose 7900/10SC</b>	model <b>RC7905</b>	article no. <b>8951000016</b>
<b>77 l large dust extraction system</b>	model <b>RC7910</b>	article no. <b>8951089014</b>
(for up to 2 tools at the same time)		

### Accessory for RODCRAFT dust extraction units:

vacuum distributor for up to 2 suction hoses 29 mm	model <b>7910VD</b>	article no. <b>8951011130</b>
5 m suction hose 29 mm		
with integrated air supply hose	model <b>205SE</b>	article no. <b>8951011111</b>
5 m suction hose 29 mm	model <b>7900/10SC</b>	article no. <b>8951011102</b>

filters for model 7900, 7905:		
standard filter (polyestervleece class L – 2700 cm <sup>2</sup> )	model <b>7900SF*</b>	article no. <b>8951011100</b>
nylon filter (anti-static layer)	model <b>7900NF*</b>	article no. <b>8951011096</b>
dust bags made of filter paper (10 pcs.)	model <b>7900SB</b>	article no. <b>8951011098</b>
dust bags made of polyester (5 pcs.)	model <b>7900SBP</b>	article no. <b>8951011103</b>
* included in delivery of model 7900		

filters and other accessory for model 7910:		
standard filter (polyestervleece class L – 5700 cm <sup>2</sup> )	model <b>7910SF**</b>	article no. <b>8951011101</b>
nylon filter (anti-static layer)	model <b>7910NF**</b>	article no. <b>8951011097</b>
dust bags made of filter paper (5 pcs.)	model <b>7910SB</b>	article no. <b>8951011099</b>
dust bags made of polyester (5 pcs.)	model <b>7910SBP</b>	article no. <b>8951011104</b>
basket, upper	model <b>7910KO**</b>	article no. <b>8951011095</b>
basket, lower	model <b>7910KU</b>	article no. <b>8951011094</b>
compressed air distributor	model <b>800*</b>	article no. <b>8951011129</b>
with 2 air multi-profile couplers		
click-connector (dust extraction unit - hose)	model <b>7900/10KA</b>	article no. <b>8951011131</b>



\*\* included in delivery of model 7910

Model	Peak power / power [W]	tank [l]	suction flow [m <sup>3</sup> /h]-[l/min]	suction height(water) [mm H2O]	electrical sockets [W]	filtration surface [cm <sup>2</sup> ]	dimension [mm]	Weight [kg]	air supply pressure [bar]	Noise [dB(A)]
RC7905	1400 / 1200	21	215 - 3583	2400	1x2000	2700	415 x 415 x 550	10,0	4 - 16	65
RC7910	2600 / 2300	77	430 - 7150	2400	2x600	5700	608 x 608 x 1060	25,1	4 - 15	67

# Orbital Block Sanders Linear Sander

**5 mm universal stroke  
70 x 125 mm  
sanding pad**

Small palm block sander with 5 mm stroke and proven hard chromed air motor. The non-perforated sanding pad is additionally equipped with clamps. Rear exhaust.



5 mm orbital block (non-perforated)

model **RC7700V** article no. **8951072181**

**2.5 mm stroke  
93 x 174 mm  
composite**

Handy and lightweight tool with small stroke for sanding fillers and for woodworking. With velcro pad 8-holes, 93 x 174 mm. The appropriate dust extraction and abrasives of various grains can be found below.

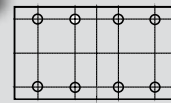

model **RC7802RV1** article no. **8951072022**

**400 x 70 mm perforated velcro pad  
5 mm orbital block sander for dust extraction  
SUPERTECH industrial motor**

For large surface sanding and profiling with 5 mm orbital stroke. Suited for continuous work due to high quality SUPERTECH industrial motor, rear exhaust (speed adjustable on the handle) and cold-insulating handles. Perforated velcro pad and flat 29 mm (nominal) suction port for use of external dust extraction systems.

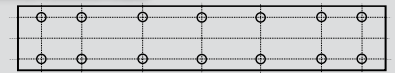

**5 mm orbital block sander  
(for dust-extraction)**

model **RC7451V** article no. **8951072102**  
**8951011590**

**400 x 70 mm sanding pad  
25 mm linear sander/body file**

This tool makes forward-reverse movements for profiling and sanding of surfaces with lots of filler (e.g. repairs of dented car doors). The sander is equipped with a non-perforated long sanding pad and clamps for normal abrasives.

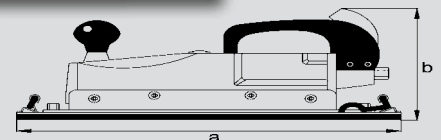

**25 mm linear sander  
(non-perforated)**

model **RC7500** article no. **8951072101**

Model	Pad [mm]	Stroke [mm]	Speed orbital [Rpm]	Weight [kg]	Inner Hose Diameter [mm]	Dimension a x b x c [mm]	Air Consumption average - continuous [l/min]		Air Inlet [Inch]	Duty Level (X)	Noise LpA [dB(A)]	Vibration [m/s <sup>2</sup> ]
RC7451V	70 x 400 <sup>VC</sup>	5	10000	2.50	8	435x130x58	360	480	1/4" IG	3	77.5	16.7
RC7500	65 x 390 <sup>C</sup>	25	3500	2.70	8	400x170	200	250	1/4" IG	2	80.1	21.3
RC7700V	70 x 125 <sup>VC</sup>	5	10000	1.10	8	180x125	360	480	1/4" IG	3	80.6	5.4
RC7802RV1	93 x 174 <sup>V</sup>	2.5	10000	1.10	8 <sup>29/27</sup>	220x120x93	450	550	1/4" IG	4	80.5	7.3



**for small areas  
clean with vacuum  
and collection bag**

①

Small sand blaster with recovery of the blasting material through self-induced suction and collection bag. With 5 different sorts of nozzles for concave and convex corners, brush nozzle, spot blasting nozzle and nozzle for sand blasting of larger surfaces in stripes. Includes a bottle of 0,8 kg copper slag blasting material.



sand blasting set

model  
**RC8113**

article no.  
8951070023

**portable with 10 l  
blasting material container**

①

Sand blaster for mobile use - just with compressed air - for working on suspension parts, rims, car bodies and many other applications. With portable blasting material container (10 l) and long hose (5 m) for connection of container and gun. Important: The blasting material has particle sizes 0,4 – 0,8 mm and it should be dry without clogs. Note that the small hole on the fitting at the tank is always kept open for an optimum air suction flow. Accessory available (except blasting material). Do not work without personal protection (goggles, dust hood etc.)



sand blaster

ceramic nozzle (5 piece set)  
gun, complete  
dust mask

model  
**RC8112**

article no.  
8951070003  
8951011689  
8951011690  
8951011681

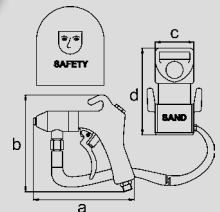

Model	Size of Particle Blasting Material [mm]	Capacity approx. [mm]	Max. Pression [Rpm]	Weight [kg]	Inner Hose Diameter [mm]	Dimension a x b x c [mm]	Air Consumption average – continuous [l/min]	Duty Level [x]	Nozzle [mm]	Air Inlet [inch]
RC8112	0.4 - 0.8	10.0	6.7	2.35	8	157x150x250x500	170 240	1	5	1/4" AG
RC8113	0.4 - 0.8	1.0	6-8	0.90	8	255x223	190 330	1	6 (65)	1/4" AG

# Paint Guns

## "Pico-Speed" mini paint gun



With 0,125 l plastic paint cup and standard nozzle 0,8 mm. Adjustable like the large paint guns - spray pattern (round, wide, swivelling nozzle head), set screw to limit paint volume and precisely dosable trigger, air flow valve.

paint gun 0,5 mm  
paint gun 0,8 mm  
0,5 mm nozzle set  
0,8 mm nozzle set  
1,0 mm nozzle set  
0,125 l cup including lid

Model	Article no.
<b>RC8103/05</b>	8951070062
<b>RC8103/08</b>	8951070012
	8951011708
	8951011709
	8951011710
	8951011711

## "Rod-Speed" 1,4 mm



Famous paint gun with 0,6 l cup and standard nozzle 1,4 mm. Adjustable spray pattern (round, wide, swivelling nozzle head), set screw to limit paint volume and precisely dosable trigger, air flow valve.

paint gun 1,4 mm  
paint gun 1,7 mm  
paint gun 2,0 mm  
paint gun 2,5 mm  
1,4 mm nozzle set  
1,7 mm nozzle set  
2,0 mm nozzle set  
2,5 mm nozzle set  
0,6 l cup including lid  
gasket kit  
paint filter mesh

Model	Article no.
<b>RC8102/14</b>	8951070002
<b>RC8102/17</b>	8951070032
<b>RC8102/20</b>	8951070042
<b>RC8102/25</b>	8951070052
	8951011703
	8951011704
	8951011705
	8951011706
	8951011695
	8951011707
	8951011696

## "Rod-Speed" HVLP-fogless



Like 8102 but here with paint optimising system "HVLP" including 1,3 mm nozzle and mini pressure regulator with gauge. Cup capacity 0,6 l. With adjustable spray pattern (round, wide, swivelling nozzle head), set screw to limit paint volume and precisely dosable trigger, air flow valve. Includes mini pressure regulator with gauge.

paint gun HVLP 1,3 mm  
paint gun HVLP 1,7 mm  
paint gun HVLP 2,0 mm  
1,3 mm nozzle set  
1,7 mm nozzle set  
2,0 mm nozzle set  
0,6 l cup including lid  
paint filter mesh  
mini pressure regulator with gauge

Model	Article no.
<b>RC8106/13</b>	8951070011
<b>RC8106/17</b>	8951070031
<b>RC8106/20</b>	8951070041
	8951011713
	8951011714
	8951011715
	8951011695
	8951011696
	8951011716

## HVLP with tilting cup

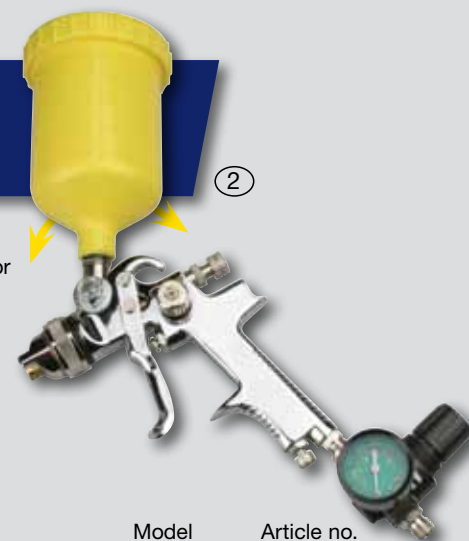

Like 8106 for working overarm with swivel joint for tilting the cup. With nozzle 1,4 mm HVLP and 0,6 l cup capacity.

paint gun with tilting cup

1,4 mm nozzle set  
1,7 mm nozzle set  
2,0 mm nozzle set  
0,6 l cup including lid  
paint filter mesh  
mini pressure regulator

Model	Article no.
<b>RC8107/14</b>	8951070021

8951011717  
8951011718  
8951011719  
8951011720  
8951011696  
8951011716

Model	Cup  [litre]	Nozzle  [mm]	Max. Pressure  [bar]	Weight  [kg]	Inner Hose Diameter  [mm]	Dimension a x b  [mm]	Air Consumption average - continuous  [l/min]	Air Inlet  [inch]	Duty Level  2	Noise LpA  [dB(A)]	Vibration  [m/s <sup>2</sup> ]
RC8102/14	0.6	1.4	2-4	0.75	8	180x340	260 370	1/4" AG	2	<70	< 2.5
RC8103/08	0.125	0.8	2	0.45	8	128x240	100 140	1/4" AG	2	<70	< 2.5
RC8106/13	0.6	1.3 HVLP	2	0.75	8	180x369	210 300	1/4" AG	2	<70	< 2.5
RC8107/14	0.6	1.4 HVLP	3	1.00	8	187x415	150 380	1/4" AG	2	<70	< 2.5

HVLP: high volume - low pressure (pressure on air inlet can be regulated precisely, low side fog and economic paint consumption) IG = female thread AG = male thread norms applied : noise according to ISO15744, more detailed specs see page 69.

### Nozzle Sets

For all our paint guns we offer further nozzle sets with different sizes for various applications.

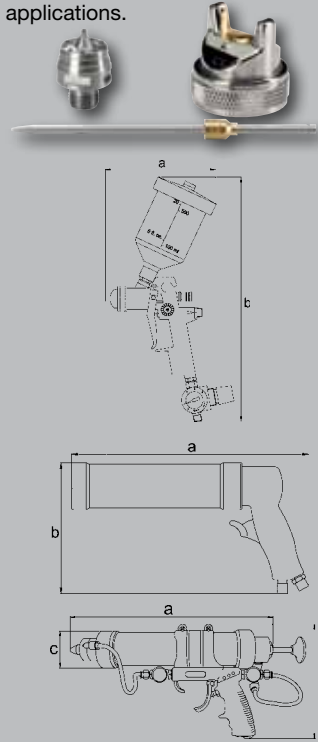

**For cartridges up to 310 ml  
(up to size 220 x 50 mm)  
steel version**



Famous and extremely robust cartridge gun with steel cylinder for cartridges up to 310 ml and up to a size of 220 x 50 mm. With adjustable air flow and pressure release valve for precise stop of the material flow without dropping. For sealants, silicones, one component glues, cements, fillers, grease in aluminium, cardboard and plastic cartridges.

cartridge gun, adjustable, steel      Model **RC8000**      Article no. **8951070000**

**for cartridges / sachets  
spraying and extrusion  
adjustable flow and quick-stop  
system**



RC8006



RC8007

Very versatile guns. For mere extrusion of material as well as for rough spraying / distribution of sealants for coverage of larger surfaces. e.g. seam sealing in car body construction and repair. With piston against undesired air in material, with safety valve against overpressure, with plastic nozzle for extrusion as well as spray nozzle. The material flow and also the spraying size are adjustable. With pressure release for precise stop of the material without drops.

Not suited for high viscosity bonding materials like glue for windcreens.

Model 8006: for cartridges up to 310 ml (up to size 220 x 50 mm).

For bags/sachets up to 400 ml

Model 8007: for cartridges up to 310 ml (up to size 220 x 50 mm).

For bags/sachets up to 600 ml

universal gun, small  
universal gun, large  
extrusion nozzle

Model      Article no.  
**RC8006**      8951070010  
**RC8007**      8951070020  
8951011702



Model	Cartridge	Bag/Sachet	Weight	Inner Hose Diameter	Dimension a x b	Air Consumption average - continuous	Air Inlet	Duty Level	Niveau LpA	Vibration
	[ml] [mm]	[ml]	[kg]	[mm]	[mm]	[l/min]	[inch]	X	[dB(A)]	[m/s²]
RC8000	up to 310 ml (up to 220x50)	-	1.1	8	305x167	0.8	1/4" IG	1	-	< 2.5
RC8006	up to 310 ml (up to 220x50)	up to 400 ml	1.2	8	340x190	0.8 (200*)	1/4" IG	3	(<70°)	< 2.5
RC8007	up to 310 ml (up to 220x50)	up to 400 ml	1.3	8	445x190	1.0 (200*)	1/4" IG	3	(<70°)	< 2.5

# Underbody Coating Gun (Schutz), Cleaning Gun, Blow Guns, Vacuum Gun



Underbody coating gun for standard 1 l containers to screw under the gun.  
 Model 8010 with metal housing and nozzle/tube  
 Model 8011 with quick change plastic nozzles and tubes.  
 Includes 2 nozzles and 2 suction tubes.  
 Optional accessory for 8011:  
 nozzle set (3 nozzles, 3 tubes)

One gun for various applications:  
**underbody coating gun** for standard 1 l bottles / cans with thread  
 cavity coating gun with long nozzle tube for 1 l containers.  
**Cleaning gun** using the 1 l tank and the long nozzle tube with adjustable nozzle ring.  
**Desinfection gun** for air conditioning systems and air channels in the car when using the tank and the long nozzle hose.

Model Article no.  
**cleaning gun RC8115 8951070034**

**underbody coating gun** Model **RC8010** Article no. **8951070030**  
 nozzle tube for 8010 **8951011694**  
**underbody coating gun, quick change** Model **RC8011** Article no. **8951070040**  
 nozzle set for 8011 **8951011679**

Model Article no.  
**4 in 1 distribution gun 8035 8951070050**

**spray can refillable 0,6 l**



① Spray bottle that can be refilled and recharged with compressed air. With safety valve and fitting to fill. Can be refilled with solvents, corrosion protection, lubricants and cleaners or simply with clean compressed air for using it like blow gun for cleaning. Max. pressure 9 bar, includes 4 different nozzle heads - the ecological alternative.



Removes sharp parts (sharps of glass), vacuums even electrically conducting dust (metal dust) or pumps water over little differences in height (emptying cars) - blow gun for gentle air pressure but high flow e.g. for cooling, drying. Tough metal body with 4 different nozzles, suction hose and dust bag made of textile.

Model Article no.  
**suction-blow-gun RC8116 8951070004**  
 2 piece nozzle set (flat, round) **8951011684**  
 brush nozzle **8951011688**  
 suction hose **8951011683**  
 dust bag **8951011686**

Model Article no.  
**refillable spray can RC8118 8951011018**  
 4 piece nozzle set **8951011697**  
 spray head, complete **8951011698**

Model	Container  [litre]	Weight  [kg]	Inner Hose Diameter  [mm]	Dimension a x b  [mm]	Air Consumption average - continuous		Air Inlet  [inch]	Duty Level  X	Nozzle  [mm]
					[l/min]	[l/min]			
RC8010	1	0.6	8	250x160	210	300	1/4" IG	1	-
RC8011	1	0.8	8	200x270x45	210	300	1/4" IG	1	-
RC8035	1	0.4	8	250x180	195	280	1/4" IG	1	5

Max. pressure 6,3 bar (90psi), for model 8035, according to application 2- 6 bar IG = female thread

Model	Size of Particle Blasting Material  [mm]	Capacity approx. <b>V</b> [litre]	Max. Pressure  [bar]	Weight  [kg]	Inner Hose Diameter  [mm]	Dimension a x b x c  [mm]	Air Consumption average - continuous		Air Inlet  [inch]	Duty Level  X	Nozzle  [mm]
							[l/min]	[l/min]			
RC8115	-	1.0	2-15	0.50	8	374x200	230	330	1/4" IG	1	5
RC8116	-	-	6	0.60	8	144x140x34x34	330	480	1/4" IG	2	-
RC8118	-	0.6	9	0.15	8	263x65	-	-	-	1	mini

IG = female thread

## blow guns

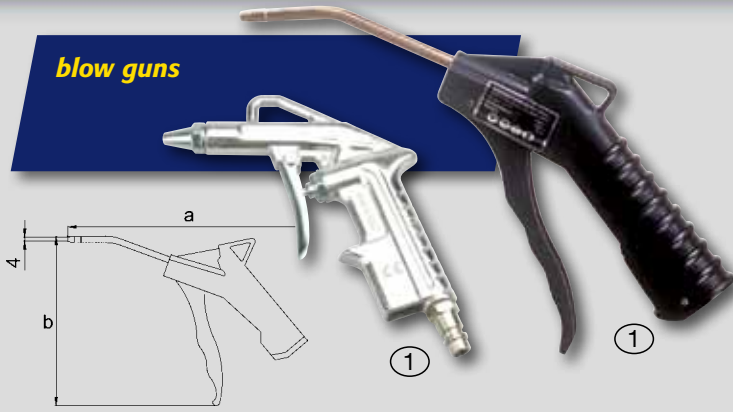

The right one for each workshop:  
**model 8120** short and handy aluminium version, 2 mm nozzle opening  
**model 8125** plastic version with insert for air inlet, 95 mm metal nozzle tube with 3 mm opening. Extra long valve lever for precise dosing of the air flow.

aluminium, short nozzle	Model	Article no.
plastic, long nozzle tube	<b>RC8120</b>	8951070014
	<b>RC8125</b>	8951070024

## pocket size blow pens



The personal equipment for each mechanic. Avoids long searching for a blow gun when in your pocket.  
**Models 8500-8504** made of high resistance anodised aluminium with adjustable air flow (nozzle ring) and clip.  
**Model 8505** easy to operate - just bend it and the integrated valve opens. Various plug profiles available:

	nipple profile	Model	Article no.
with flow adjustment ring	<b>DIN 7.2 - 7.4 (Euro profile)</b>	<b>RC8502</b>	8951011024
	ISO 6150 B (MIL-C-4109)	RC8500	8951011022
	ISO 6150 C (Stäubli)	RC8501	8951011023
	Britisch (PCL)	RC8503	8951011025
	ARO 210 (Orion)	RC8504	8951011026
with bend-it-valve	<b>DIN 7.2 - 7.4 (Euro profile)</b>	<b>RC8505</b>	8951011027

## composite blow guns soft start valve low noise safety nozzle versions

European guns made of durable high quality materials, manufactured with precision. 4 versions available with soft, silencing safety nozzle or standard type nozzle / long nozzle or short nozzle. Safety nozzles prevent scratching painted surfaces, injuries and reduce noise. High air flow rate even at low pressure – double blow power than standard guns. Good for soft starting due to an easy to regulate valve. Tough composite housing insulates against cold from air. With soft TPR-rubber area on the lever and ergonomic handle-lever distance for reduced stress to the user. With durable stainless steel valve springs, tubes (nozzles only RC8241, RC8241S). Very sturdy air inlet with threaded brass insert. Practical large hanger for fast storage and immediate availability.



	Model	Article no.
with short nozzle	<b>RC8240</b>	8955000026
with safety nozzle, short	<b>RC8240S</b>	8955000009
with long nozzle tube	<b>RC8241</b>	8955000010
with safety nozzle on long tube	<b>RC8241S</b>	8955000011

Model	Max. Pressure [bar]	Weight [kg]	Inner Hose Diameter [mm]	Dimension a x b x c x d [mm]	Air Consumption average – continuous [l/min]	Air Inlet [inch]	Duty Level (X)	Nozzle [mm]	Noise LpA [dB(A)]
RC8120	2 - 15	0.20	8	140x145	130 190	1/4" IG	1	2	
RC8125	2 - 7	0.10	8	226x157	250 350	1/4" IG	1	3	
RC8502	12	0.02	8	109x10	220 300	Euro 7.2	2	3	
RC8505	12	0.08	8	129x12x6	220 300	Euro 7.2	2	3	
RC8240	-	0.123	8	191x134	290 432	1/4" IG	3	2	78,2
RC8240S	-	0.124	8	200x134	220 329	1/4" IG	4	S	75,1
RC8241	-	0.136	8	262x151	310 463	1/4" IG	3	4	79,5
RC8241S	-	0.141	8	294x151	235 352	1/4" IG	4	S	73,4

# Grease Guns

**single stroke  
170 bar  
cartridges  
and loose**



②

Grease gun for cartridges 215 x 50 mm and for loose grease (max. 400 ml). Single stroke output - see explanation in the box on the right. Delivery includes a rigid nozzle tube (c = 116 mm) and a flexible high-pressure hose (c = 270 mm) - each with a grease plug chuck.

Model Article no.  
**RC8132** 8951000059

**pumping  
250 bar  
cartridges  
and loose**



②

Grease gun for cartridges 215 x 50 mm and for loose grease (max. 400 ml). Pumping function - see explanation in the box on the right. Delivery includes a rigid nozzle tube (c = 116 mm) and a flexible high-pressure hose (c = 270 mm) - each with a grease plug chuck.

Model Article no.  
**RC8142** 8951000060

**pumping  
260 bar  
cartridges  
and loose**



③

Grease gun with cold-insulated handle for cartridges 215 x 50 mm (400 ml) but also for loose grease. The grease gun delivers continuously grease as long as the trigger is pushed. Includes a rigid nozzle tube and a flexible high-pressure hose (c = 225 mm).

Model Article no.  
**RC8141** 8951070090

**pumping 440 bar,  
swivelling body  
large cartridges and loose**

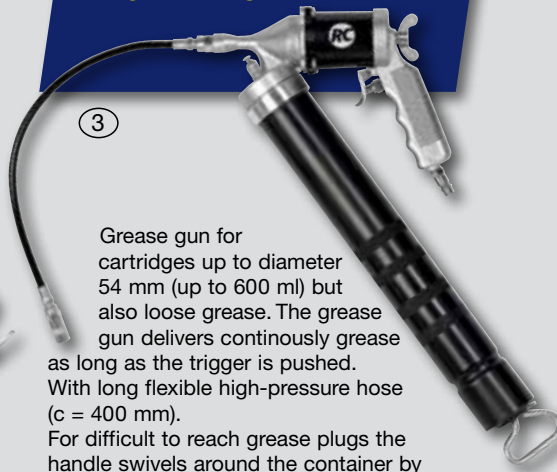

③

Grease gun for cartridges up to diameter 54 mm (up to 600 ml) but also loose grease. The grease gun delivers continuously grease as long as the trigger is pushed. With long flexible high-pressure hose (c = 400 mm). For difficult to reach grease plugs the handle swivels around the container by 360°.

Model Article no.  
**RC8135** 8951070070

## Grease Guns

**Single stroke function:**  
Grease guns for a cautious greasing service, for low grease and air consumptions (smaller compressor). Only a small portion of grease is pressed out with every push onto the trigger.

**Pumping function:**  
For an output of larger amounts of grease and for a broad variety of applications, RODCRAFT is offering grease guns that can pump grease continuously as long as the trigger is pressed. Typically used to top up onboard central greasing units and saddle plates etc. but also for fast maintenance on greasing plugs with varying need for grease. Small amounts of grease can be given by pressing the trigger only briefly.

**Cartridges - loose grease:**  
Most grease guns can be used for both types after having given the piston seal the right orientation - please see the manual.

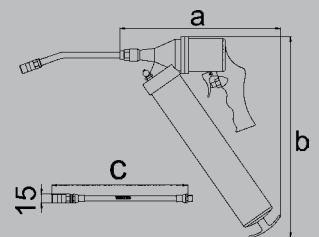

For mini grease guns see page 65

Model	Output Pressure (Compression ratio) [bar]	Flow Rate V	Max. Pressure. [bar]	Weight kg [kg]	Inner Hose Diameter [mm]	Dimension a x b x c [mm]	Air Consumption average - continuous l/min	Duty Level x	Air Inlet [inch]
RC8132	170	0,4 g/stroke	8	1.53	8	264x328	3 l/stroke	2	1/4" IG
RC8135	440*	400g/min continuously	10	1.6	8	280x500	230 300	3	1/4" IG
RC8141	260	120 g/min continuously	8	1.6	8	260x328	90 110	3	1/4" IG
RC8142	250	64 cm <sup>3</sup> /min continuously	8	1.53	8	264x328	100 140	2	1/4" IG

## 3/8" square drive



Short and long sockets with hex key, impact proof chrome-molybdenum quality, easy-to-read laser etched marking on each socket with model no. and key size



description	size of hexagonal key [mm]	model	Article no.
short sockets set 13 piece in tool box	7, 8, 9, 10, 11, 12, 13, 14, 15, 16, 17, 18, 19	<b>RS3113</b>	8951012354
long sockets set 13 piece in tool box	7, 8, 9, 10, 11, 12, 13, 14, 15, 16, 17, 18, 19	<b>RS3113D</b>	8951012355

## 1/2" square drive



Short and long sockets with hex key, impact proof chrome-molybdenum quality, easy-to-read laser etched marking on each socket with model no. and key size, individual long sockets also available (3 models)



short sockets set 14 piece in tool box	10, 11, 12, 13, 14, 15, 16, 17, 18, 19, 21, 22, 26, 27	<b>RS4114</b>	8951012356
long sockets set 14 piece in tool box	10, 11, 12, 13, 14, 15, 16, 17, 18, 19, 21, 22, 26, 27	<b>RS4114D</b>	8951012357
short sockets set 3 piece in tool box	17, 19, 21	<b>RS413DTW</b>	8951012353

Individual sockets, long version - for difficult to reach bolts and nuts. Confectionated with hanger and label.

single socket with hanger	17 mm	D=26,0	D1=26,0	L=78,0	<b>R417MD</b>	8951012364
single socket with hanger	19 mm	D=28,0	D1=28,0	L=78,0	<b>R419MD</b>	8951012365
single socket with hanger	21 mm	D=30,0	D1=30,0	L=78,0	<b>R421MD</b>	8951012366

## with anti-scratch protection



Long sockets with hex key, with anti-scratch protection, extra thin-walled for alloy rims, painted rims and polished cap nuts, impact proof chrome-molybdenum quality, easy-to-read marking on each socket with key size, individual sockets also available



set 3 piece in tool box	17, 19, 21	<b>RS413WP</b>	8951012362
set 4 piece in tool box	17, 19, 21, 22	<b>RS414WP</b>	8951012363

single socket (blue) with hanger	17 mm	D=30,0	D1=23,8	L=85,0	<b>R417MWP</b>	8951012372
single socket (yellow) with hanger	19 mm	D=30,0	D1=26,0	L=85,0	<b>R419MWP</b>	8951012373
single socket (red) with hanger	21 mm	D=30,0	D1=28,0	L=85,0	<b>R421MWP</b>	8951012374
single socket (orange) with hanger	22 mm	D=32,0	D1=29,5	L=85,0	<b>R422MWP</b>	8951012375
sleeve anti-scratch (10 pcs) for R417MWP					<b>KSW17LK</b>	8951011402
sleeve anti-scratch (10 pcs) for R419MWP					<b>KSW19LK</b>	8951011403
sleeve anti-scratch (10 pcs) for R421MWP					<b>KSW21LK</b>	8951011404
sleeve anti-scratch (10 pcs) for R422MWP					<b>KSW22LK</b>	8951011405

# Sockets

## 1/2" square drive - special



Special sockets with Star tip (TORX) and hexagonal (Allen, Inbus) male key ends - indispensable for many vehicle applications like truck doors, covers etc. - length 790 mm



description	shape and sizes	model	article no.
Star tip ("TORX") set 8 piece in tool box	T25, T27, T30, T40, T45, T55, T60	RS438T	8951012377
Hex tip ("Allen", "Inbus") set 8 piece in tool box	H6, H7, H8, H10, H12, H14, H17, H19	RS438A	8951012376

## Torsion bars with both ends 1/2" square drive (male and female), total length 1940 mm



description	data on bar (colour)	model	article no.
torsion bars set 5 piece in tool box	100 Nm (black), 110 Nm (blue), 120 Nm (white), 135 Nm (grey), 150 Nm (orange)	RS435B	8951012378

## 3/4" square drive



Short and long sockets with hex key, impact proof Chrome-Molybdenum quality, easy-to-read laser etched marking on each socket with model no. and key size



description	size of hexagonal key [mm]	model	article no.
short sockets set 8 piece in tool box with metal locks	26, 27, 29, 30, 32, 35, 36, 38	RS618	8951012358
long sockets set 8 piece in tool box with metal locks	26, 27, 29, 30, 32, 35, 36, 38	RS618D	8951012359

## 1" square drive



Short and long sockets with hex key, impact proof Chrome-Molybdenum quality, easy-to-read laser etched marking on each socket with model no. and key size, individual sockets also available (5 models)





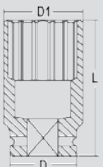



description	size of hexagonal key [mm]	model	article no.
short sockets set 8 piece in tool box with metal locks	26, 27, 29, 30, 32, 35, 36, 38	RS818	8951012360
long sockets set 4 piece in tool box	27, 32, 33, 36	RS814D	8951012361

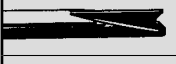
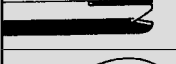

single socket with tag	27 mm	D=40,0 D1=40,0 L=85,0	R827MD	8951012367
single socket with tag	30 mm	D=44,0 D1=44,0 L=85,0	R830MD	8951012368
single socket with tag	32 mm	D=44,0 D1=44,0 L=85,0	R832MD	8951012369
single socket with tag	33 mm	D=44,0 D1=47,0 L=85,0	R833MD	8951012370
single socket with tag	36 mm	D=44,0 D1=51,0 L=85,0	R836MD	8951012371



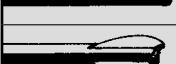

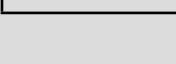

## Chisels for car body and metal applications

Model	5100-5180	5305	5400
	chisel shaft end	11.0 mm	12.0 mm
	RC 14 S 8951011923 (135 mm)		
	RC 16 S 8951011924 (127 mm)		
	RC 18 S 8951011925 (140 mm)		
	RC 19 S 8951011926 (29x140 mm)		
	RC 20 S 8951011927 (19x135 mm)		RC 92 8951011953 (30x190 mm)
	RC 22 S 8951011928 (20x140 mm)		
	RC 30 S 8951011929 (12x123 mm)		
	RC 60 S 8951011930 (140 mm)		
		RC 51 S 8951011949 (160 mm)	RC 93 8951011954 (185 mm)

\* round shank version 10,2 mm : model RC20, 8955510712 (19 x 85 mm)

## Can be found in sets with hammer

5120	5150	5160	5176	5310
11.0 mm	11.0 mm	11.0 mm	11.0 mm	12.0 mm
				
X				
X				
X				
X				





(chisel width x effective length)

## Chisels for concrete and stone applications

	pointed chisel	SS10 8951011932 (210 mm)	SS10K* 8951011933 (135 mm)	RC 51 S 8951011949 (160mm)	RC 93 8951011954 (185 mm)
	flat chisel 20 mm	SS20 8951011934 (210 mm)	SS20K* 8951011935 (140 mm)	RC 52 S 8951011950 (210 mm)	
	flat chisel 30 mm	SS30 8951011936 (205 mm)	SS30K* 8951011937 (140 mm)	RC 53 S 8951011951 (210 mm)	RC 92 8951011953 (30x190 mm)
	flat chisel 40 mm	SS40 8951011938 (210 mm)	SS40K* 8951011939 (135 mm)	RC 53 S 8951011951 (210 mm)	
	hollow gap chisel		SS50* 8951011940 (200 mm)	RC 54 S 8951011952 (210 mm)	
	* in chisel set		RC 61S 8951011931		

	X		X	X
	X		X	X
	X			X
	X			X
	X			

## Chisel hammer accessory

	retainer spring	RC 70 8951011958		
	retainer, solid alum.	RC76 8951011961		
	retainer, sold steel	RC76-1 8951011962	RC 76-3 8951011964	RC 94 8951011955
	retainer quick-chuck	RC 73 8951011960		
	spring for steel cap	RC 70 8951011958	RC 79 8951011963	RC 95 8951011956

X		X		
	X		X	

## Truck brake service

	6 mm	RC 40 S-6 8951011942		
	8 mm	RC 40 S-8 8951011943		
	10 mm	RC 40-10 8951011941		
	8 mm	RC 41 S-8 8951011945		
	10 mm	RC 41-10 8951011944		
	6 mm	RC 42 S-6 8951011947		
	8 mm	RC 42 S-8 8951011948		
	10 mm	RC 42-10 8951011946		

		X		
		X		
		X		

# Magnetic Dishes Staples, Brads

## handy magnetic dishes

ideal storage for small parts  
e.g. screws, nuts etc.

applicable in every position  
also overarm

all magnetic dishes are made of stainless steel  
magnets with rubber cover  
to avoid scratches



MAGT1





MAGT2



MAGT3



MAGT4



model	diameter dish 	diameter magnets [mm]	weight  [kg]
MAGT1	Ø 150	63	0.3
MAGT2	240 x 140	2 x 83	0.67
MAGT3	360 x 160	3 x 83	0.99
MAGT4	235 x 250	4 x 83	1.19

round  
short rectangular  
medium rectangular  
large square

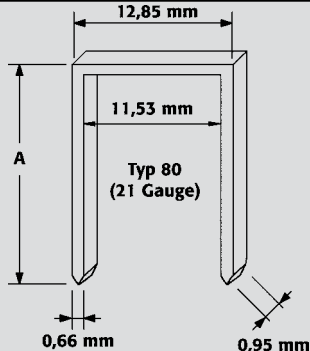
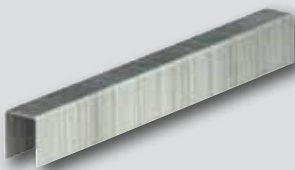

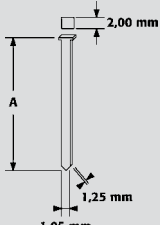
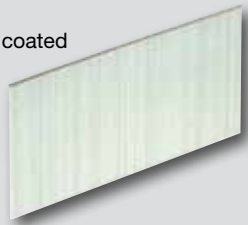
Model	Article no.
MAGT1	8951011488
MAGT1	8951011489
MAGT1	8951011490
MAGT1	8951011491

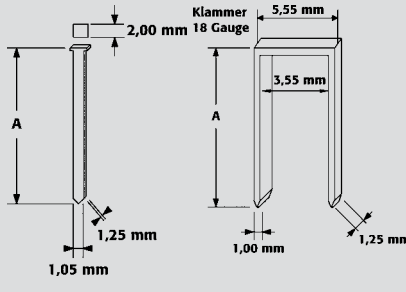
	Type	A (mm)	for model	quantity	model	order no.
	staple type 80 zinc coated 	6	RC5900/RC5905	10.000	K80-06CNK	8951012234
	8	RC5900/RC5905	10.000	K80-08CNK	8951012235	
	10	RC5900/RC5905	10.000	K80-10CNK	8951012236	
	12	RC5900/RC5905	10.000	K80-12CNK	8951012237	
	14	RC5900/RC5905	10.000	K80-14CNK	8951012238	
	16	RC5900/RC5905	10.000	K80-16CNK	8951012239	

	brad zinc coated 	A (mm)	for model	quantity	model	order no.
		20	RC5910/RC5940	5.000	J12-20CNK	8951012240
25	RC5910/RC5940	5.000	J12-25CNK	8951012241		
32	RC5910/RC5940	5.000	J12-32CNK	8951012242		
40	RC5910/RC5940	5.000	J12-40CNK	8951012243		

	staples type 90 zinc coated (galvanised) 	A (mm)	for model	quantity	model	order no.
		20	RC5940	5.000	K90-20CNK	8951012244
25	RC5940	5.000	K90-25CNK	8951012245		
30	RC5940	5.000	K90-30CNK	8951012246		
32	RC5940	5.000	K90-32CNK	8951012247		
38	RC5940	5.000	K90-38CNK	8951012248		
40	RC5940	5.000	K90-40CNK	8951012249		

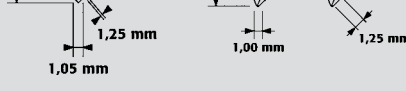
	brad zinc coated (galvanised) 	A (mm)	for model	quantity	model	order no.
		20	RC5940/RC5910	5.000	J12-20CNK	8951012240
25	RC5940/RC5910	5.000	J12-25CNK	8951012241		
32	RC5940/RC5910	5.000	J12-32CNK	8951012242		
40	RC5940/RC5910	5.000	J12-40CNK	8951012243		

Please observe the safety instructions for pneumatic nailers/staplers.

## standard length



applications / car part	for saw types	teeth per inch	distance of teeth	material	A	model	order no.
steel, sheet metal / car body	RC 6040RE RC 6050 RC 6060RE RC 6065RE RC 6067RE	32	0,8	bi-metal	4,2	605132	8951011514
casted iron, aluminium, copper, zinc, plastic / bumper		24	1,0	bi-metal	4,2	605224	8951011515
plastic, wood / bumper		18	1,4	bi-metal	4,2	605818	8951011520
plastic, wood		14	1,8	bi-metal	4,2	605814	8951011519

## extra long



applications / car part	for saw types	teeth per inch	distance of teeth	material	A	model	order no.
steel, sheet metal / car body	RC 6050 RC 6060 RC 6065 RC 6067	32	0,8	bi-metal	4,2	SB32L	8951011521
casted iron, aluminium, copper, zinc, plastic / bumper		24	1,0	bi-metal	4,2	SB24L	8951011522
plastic, wood		18	1,4	bi-metal	4,2	SB18L	8951011523

## SIG type

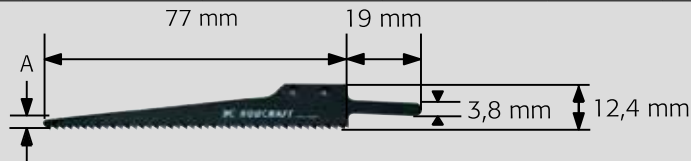

applications / car part	for saw types	teeth per inch	distance of teeth	material	A	model	order no.
steel, sheet metal / car body	SIG	32	0,8	bi-metal	4,0	605532	8951011517
casted iron, aluminium, copper, zinc, plastic / bumper		24	1,0	bi-metal	4,0	605424	8951011516
plastic, wood / bumper		14	1,8	bi-metal	4,0	605618	8951011518

## files

	type	for model	consists of	model	article no.	
	file set	RC6900, RC6910, (RC6067)*	models 6067F, 6067R, 6067H, 6067D	6901	8951011529	
	file, flat 10x3mm	RC6900, RC6910, (RC6067)*		L :115 mm Ø : 6 mm	6067F	8951011532
	file, round 6 mm	RC6900, RC6910, (RC6067)*			6067R	8951011533
	file, half-round 10x3,8 mm	RC6900, RC6910, (RC6067)*			6067H	8951011534
	file, triangular 7x7 mm	RC6900, RC6910, (RC6067)*			6067D	8951011535
	file adapter	RC6067		6067A	8951011531	

\* files with 6 mm shaft can only be used with saw models 6067 and 6068, when applying an adapter model 6067A (846903) along with the files.

# Sanding Belts and Accessory for Machines with Collets

## sanding belts

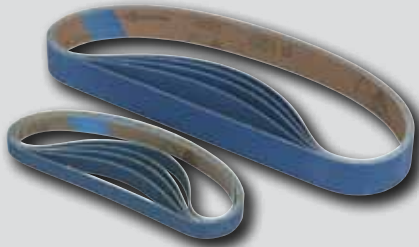

width x circumference [mm]	for model	grain	pcs. in pack	model	article no.
10 x 330	RC7155	P 40	10	7155 SB 040	8951011604
		P 80	10	7155 SB 080	8951011570
		P 120	10	7155 SB 120	8951011577
		P 180	10	7155 SB 180	8951011578
		P 240	10	7155 SB 240	8951011579
20 x 520	RC7156	P 80	10	7156 SB 080	8951011580
		P 120	10	7156 SB 120	8951011581
		P 180	10	7156 SB 180	8951011582
		P 240	10	7156 SB 240	8951011583
30 x 540	RC7157	P 80	10	7157 SB 080	8951011592
		P 120	10	7157 SB 120	8951011593
		P 180	10	7157 SB 180	8951011594
		P 240	10	7157 SB 240	8951011595

## collets



diameter shaft [mm]	for model	model	article no.
3	RC7010, RC7011, RC7015RE, RC7020, RC7040, RC7045, RC7047, RC7080, RC7100RE, RC7107	SPZA3	8951011460
1/8"	RC7010, RC7011, RC7015RE, RC7020, RC7040, RC7045, RC7047, RC7080, RC7100RE, RC7107	SPZA1/8"	8951011477
3	RC7050RE	SPZE3	8951011483
6	RC7010, RC7011, RC7015RE, RC7020, RC7040, RC7045, RC7047, RC7080, RC7100RE, RC7107	SPZA6	8951011480
1/4"	RC7010, RC7011, RC7015RE, RC7020, RC7040, RC7045, RC7047, RC7080, RC7100RE, RC7107	SPZA1/4"	8951011478
6	RC7018, RC7019, RC7029, RC7049	SPZB6	8951011486
6	RC7109	SPZC6	8951011481
6	RC7025RE, RC7026RE, RC7060RE, RC7065RE	SPZD6	8951011482
8	RC7025RE, RC7026RE, RC7060RE, RC7065RE	SPZD8	8951011485

## carborundum grinding points



diameter shaft [mm]	amount	model	article no.
3	5	K 03	8951011573
6	5	K 06	8951011574

## Roloc® accessory



backing pads for Roloc® accessory			
shaft / thread	diameter	model	article no.
6 mm	15 mm (1/2") 1 piece	3MA 0615	8951011629
6 mm	50 mm (2") 3 piece	3M2TA2	8951011631
1/4"-20 UNC IG	50 mm (2") 2 piece	-	8955000005
1/4"-20 UNC IG	75 mm (3") 2 piece	-	8955000004

strip discs with Roloc for paint / rust removal				
	diameter	pcs. in pack	model	article no.
Roloc, siafix	50 mm (2")	5	3MFS50	8951011557
Roloc, siafix	75 mm (3")	5	3MFS75	8951011558

Bristle discs			
	diameter	model	article no.
Roloc, siafix	50 mm (2")	3M50K50, green	8951011633
Roloc, siafix	50 mm (2")	3M50K80, yellow	8951011635
Roloc, siafix	50 mm (2")	3M50K120, white	8951011634

for rotating sanders, grinders, cutters				
<b>cutting discs</b>				
	dimension [mm]	model	for model	article no.
	75 x 10 x 2	70 TR	RC7190	8951011536
	115 x 22 x 3	115 TR	RC7165 / RC7166	8951011539
	178 x 22 x 3,4	178 TR	RC7180 / RC7186	8951011541
<b>grinding discs</b>				
	100 x 16	100 SCH	RC7160	8951011540
	115 x 22	115 SCH	RC7165 / RC7166	8951011542
<b>backing discs</b>				
	75 x 22	316-2	RC7150 / RC7153	8951011544
	105 x 22	416-2	RC7150 / RC7153	8951011545
	125 x 22	516-2	RC7150 / RC7153	8951011548
	170 x 5/8"	716-2*	RC7120 / RC7183	8951011546
<b>lock nut for backing pad</b>	5/8"		RC716-2	8950250605
<b>key for lock nut</b>				8950290097
<b>rubber backing discs</b>				
	* Please order a lock nut and a nut key along with your orders of backing pads model 716-2.			
	110 x 22	416-3	RC7150 / RC7153	8951011547
polishing systems				
<b>polishing lamb wool</b>				
	150 velcro	PH 15	RC7680/RC7135/RC7137	8951011586
	170 (to tie)	PH 18	RC7130	8951011550
<b>polishing felt</b>				
	75 velcro	PS 75	RC7135 / RC7137	8951011556
<b>polishing sponge</b>				
	150 velcro	PST 15	RC7680/RC7135/RC7137	8951011587
		75 velcro	SPT-75	RC7135 / RC7137
<b>backing discs</b>				
	Ø170 / 5/8"	TPT-18	RC7130	8951011549
	Ø75 / 5/16" velcro	JS3WK	RC7135 / RC7137	8951011560
<b>sponge pad</b>				
	160 x 5/8"	PST-16	RC7130	8951011551
<b>scotch mesh pad (super soft)</b>				
	150 x 5/8"	GLT-150	RC7140	8951011552
<b>velcro pad</b>				
	150 x 5/8"	KT-150	RC7120	8951011554
	150 x M14x2	KT-150M14	RC7120	8951011605

# Sanding Pads and Polishing Accessory

## non-perforated pads

	diameter pad [mm]	thread	connection	hard / soft	model	Version	article no.
	30	5/16" AG	micro-velcro	medium	EPD30SOMVFS	<i>The Expert's Pad</i>	8951011645
30	5/16" AG	self-adhering	soft	EPD30SOSFS	<i>The Expert's Pad</i>	8951011646	
30	-	velcro	soft	109	Standard	8951011610	
32	5/16" AG	velcro	soft	JS1WK	Standard	8951011575	
50	5/16" AG	velcro	soft	JS2K	Standard	8951011561	
50	5/16" AG	velcro	medium		Standard	8955000007	
75	5/16" AG	velcro	soft	JS3WK	Standard	8951011560	
75	5/16" AG	velcro	medium		Standard	8955000006	
75	5/16" AG	velcro	soft	105	Standard	8951011608	
77	5/16" AG	velcro	medium	EPC77MOVFS	<i>The Expert's Pad</i>	8951011644	
110	5/16" AG	self-adhering	hard	JS4H	Standard	8951011562	
125	5/16" AG	self-adhering	hard	JS5H	Standard	8951011563	
150	5/16" AG	self-adhering	soft	JS6W	Standard	8951011564	
150	5/16" AG	velcro	hard	JS6HK	Standard	8951011565	
150	5/16" AG	velcro	soft	JS6WK	Standard	8951011566	
100	M 14 x 2 IG	velcro	soft	JS4WK	with hole for water	8951011601	
150	5/8" IG	velcro	soft	KT-150	Standard	8951011554	
150	5/8" IG	self-adhering	soft	JS6W-1	Standard	8951011559	

## perforated pads for models

7618/7665/7666/7667/7668/7669/7670/7675/7676/7677/7678/7679 /7802V6/7805V6/7810V6

	diameter pad / no. of holes	thread	diameter circle of hole positions [mm]	connection	hard / soft	model	type	article no.
	125 / 6	5/16" AG	80	velcro	soft	JS5GWK6L80	Standard	8951011597
125 / 8	5/16" AG	65	velcro	medium	EPA125M8V	<i>The Expert's Pad</i>	8951011642	
125 / 8	5/16" AG	65	velcro	très soft	EPA125S8V	<i>The Expert's Pad</i>	8951011643	
150 / 6	5/16" AG	80	velcro	soft	JS6GWK	Standard	8951011567	
150 / 6	5/16" AG	80	velcro	hard	JS6GHK	Standard	8951011603	
150 / 6	5/16" AG	80	self-adhering	hard	JS6GHF	Standard, flat	8951011598	
150 / 6	5/16" AG	80	velcro	hard	JS6GHKF	Standard, flat	8951011599	
150 / 6 + 1	5/16" AG	80	velcro	hard	EPA150H6V	<i>The Expert's Pad</i>	8951011636	
150 / 6 + 1	5/16" AG	80	velcro	medium	EPA150M6V	<i>The Expert's Pad</i>	8951011638	
150 / 6 + 1	5/16" AG	80	velcro	super-soft	EPA150S6V	<i>The Expert's Pad</i>	8951011640	
150 / Univ.	5/16" AG	65 / 80 / 120	self-adhering	soft	JS6GWU	Standard	8951011568	
150 / Univ.	5/16" AG	65 / 80 / 120	velcro	soft	JS6GWKU	Standard	8951011569	
150 / 8 + 1	5/16" AG	120	velcro	hard	EPA150H9V	<i>The Expert's Pad</i>	8951011637	
150 / 8 + 1	5/16" AG	120	velcro	medium	EPA150M9V	<i>The Expert's Pad</i>	8951011639	
150 / 8 + 1	5/16" AG	120	velcro	super-soft	EPA150S9V	<i>The Expert's Pad</i>	8951011641	
150 / 15 6, 6 + 1, 8 + 1	5/16" AG	80 120	micro-velcro	hard		Standard, flat	8955000012	

## perforated pads for models 7691V

	diameter pad / no. of holes	diameter circle of hole positions [mm]	connection	hard / soft	model	article no.
	200 / 8	120	velcro	hard		8951012348

Pads with 6 borings for heavy duty pad fixation with 6 bolts M4.  
AG: male thread IG: female thread

balancing range (kg)	stroke (mm)	model		A	B	C	D
0,4 – 1,0	1600	9311	8951011260				
1,0 – 2,5	2000	9320	8951011263		x		
1,0 – 2,0	1600	9312	8951011261				
2,0 – 4,0	2000	9321	8951011264		x		
2,0 – 3,0	1600	9313	8951011262				
2,0 – 4,0	2500	9336	8951011267		x		
2,0 – 4,0	2500	9346	8951011272		x	o	
4,0 – 6,0	2000	9322	8951011265		x		
4,0 – 7,0	2000	9354	8951011276		x		
4,0 – 6,0	2500	9337	8951011268		x		
4,0 – 6,0	2500	9347	8951011273		x	o	
6,0 – 8,0	2000	9323	8951011266		x		
6,0 – 8,0	2500	9338	8951011269		x		
6,0 – 8,0	2500	9348	8951011274		x	o	
7,0 – 10,0	2000	9355	8951011277	x	x		
8,0 – 10,0	2500	9339	8951011270		x		
8,0 – 10,0	2500	9349	8951011275		x	o	
10,0 – 14,0	2000	9356	8951011278	x	x		x
10,0 – 14,0	2500	9340	8951011271		x		x
14,0 – 18,0	2000	9357	8951011279	x	x		x
18,0 – 22,0	2000	9358	8951011280	x	x		x
25,0 – 30,0	2000	9364	8951011285	x	x		x
35,0 – 45,0	2000	9366	8951011287	x	x		x
45,0 – 55,0	2000	9367	8951011288	x	x		x
65,0 – 75,0	2000	9369	8951011290	x	x		x



model  
9311 / 9312 /  
9313 / 9336 /  
9337 / 9338 /  
9339 / 9340



model  
9346 / 9347 /  
9348 / 9349

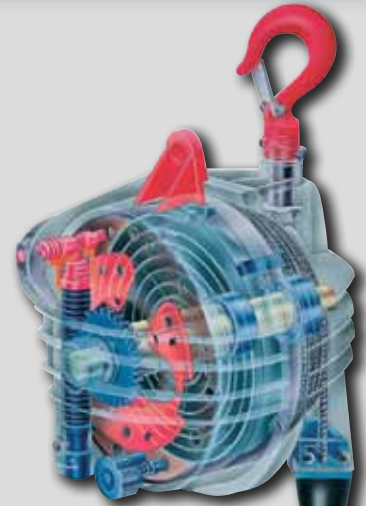

model  
9364 / 9365 /  
9366



- Stainless steel cable
- The stroke can be limited in retraction for optimum position to grab the load - simple adjustable clamp
- Cable runs in low friction material
- Fast and easy exchange of the spring package due to modular design
- Robust casted aluminium body (closed two piece construction (see A))
- Precisely adjustable balancing force (spring tension) for minimum pull resistance (grabbing) and easy setting of the balancing point
- With additional safety suspension

A aluminium casted body (closed two piece construction), upper suspension with safety hook running on ball bearing, tapered drum with ball bearing for even pull force for balancing effect over full stroke after grabbing the load

B equipped with a safety lock system against drop in case of a spring breakage (for capacities over 3 kg minimum load)

C permanently visible cable for fast security checks at any time, hook on upper suspension can be aligned Stop system to position the load at any height ("STOP" only for models marked with "o" in the table, picture see above)

D Locking the load at any position - Locking system can be operated from below by pulling on chains (remote control) - order no. 8951011304 "Option B"

balancing range (kg)	stroke (mm)	model		A	B	C	D	inlet thread	outlet thread
0,4 – 0,8	1350	9200	8951011256					1/4"	1/4" ***
0,75 – 1,5	1350	9201	8951011257					1/4"	1/4" ***
1,2 – 2,5	1350	9202	8951011258					1/4"	1/4" ***

hoses made of polyurethane (hose instead of a cable) /

\* available on request / 8 bar max. operating pressure /  
outer hose diameter 7,8 mm / \*\*\* fitting swivels

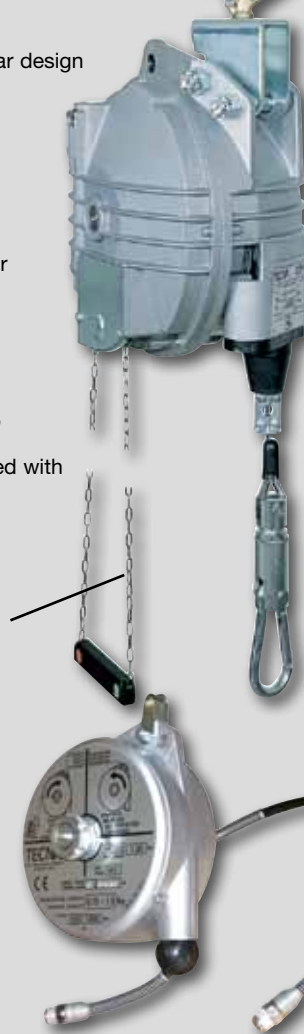

model  
9200 / 9202

## Important requirements for the use of air tools!

In order to maintain the power of a pneumatic motor, to avoid damage and to prolong the tool's life time the compressed air has to meet certain quality standards.

It's recommended to install a maintenance unit at each compressed air outlet or work place.

The following conditions for operation are of great importance and should be observed closely. For each type of work place the correctly suited maintenance unit will produce optimum conditions for the used air tools.

### Air Pressure

The standard pressure of the supplied air should be 6.3 bar (90 psi) at the air entrance of the air tool (also when air is flowing). Air inlet pressures that are too high will lead to excessive wear and failure of the tool after a while. Tools operating with too low air pressure are usually lacking in their full performance.

### Air Quantity

Depending on the type of air tool the air consumption during full performance may vary.

Please compare the max. air consumption values for tools indicated in our manuals and catalogues, the recommended hose sizes (inner diameter) with the max. flow rates of the maintenance units and the effective capacity of your compressor.

### Condense / Dirt

The water separators and filters which are integrated in our maintenance units avoid corrosion in air motors and supply clean air. A high content of water in the compressed air will lead to rust and smaller passages in steel pipes and air lines which means air pressure losses and a lack of performance of the air tools.

If no filters are used, rust and particles will damage or block the motor.

### Lubrication

Periodical lubrication of air motors is absolutely required (daily) to maintain full performance of the motor, to prolong the life time of the motor and to prevent corrosion. If a motor is not running with continuous air lubrication (lubricator), it should be lubricated manually every day (approx. 2 cm<sup>3</sup> air oil (model 1000L) . Please see also the drawing for installation in the manual.

### Operating Manuals

Please follow the instructions for maintenance and safe use in the operating manual (drawing for installation).

**When a tool was not used according to the requirements for correct operation and air preparation we will not be able to grant any warranty in case of failure.**

### Examples of Installation:

Maintenance units without lubricator but with coalescing filter for use with eg paint guns, blow guns and for oil-free operations.



Maintenance units with lubricator (slim or broad design) for all tools that require permanent lubrication.

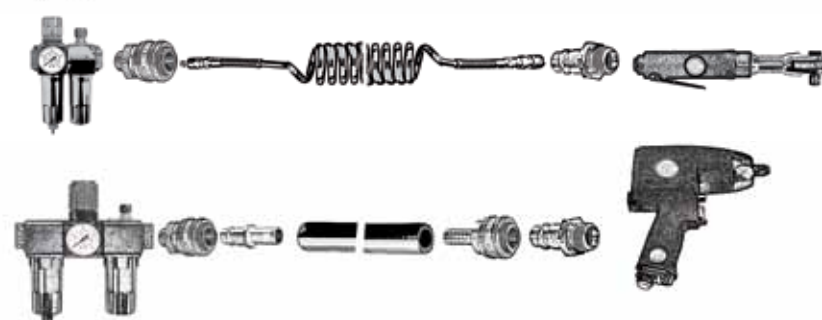

### Duty Level

In order to help you selecting the correct tool we classified all RODCRAFT tools according to duty levels:

① normal duty

② heavy duty

③ very heavy duty

④ ultra heavy duty



### maintenance units (5 micron)

Delivers clean, dry and lubricated air at constant pressure for air tools and other compressed air activators: water separator with automatic drain, filter element with 5 micron, micro-fog lubricator with flow sensor for almost constant oil/air ratio for several air tools in use, oil sight dome allows 360° visibility as well as simple adjustment and installation, metal bowls with bajonet quick release and prismatic full level sight windows for high inlet pressure and increased safety, fast element clamping system allows front access and individual removal of elements, wall fixation bracket

2 piece slim version : water separator – filter – regulator and gauge + lubricator  
 3 piece low height version : water separator – filter + regulator and gauge + lubricator  
 pressure gauge: diameter 40 mm, 0-10 bar / 90 psi for FRL units 1/4" - article no. 8940169178,  
 diameter 50 mm, 0-10 bar / 90 psi for FRL units 1/2" - article no. 8940169180

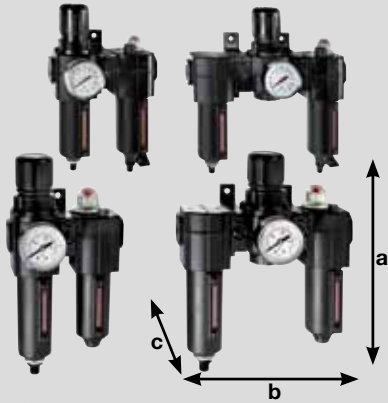

thread (inch)	pressure (IN / OUT) (bar)	max. air flow rate (l/min)	oil capacity (ml)	construction	dimension axbxc (mm)	model	article no.
1/4" G	10 / 0 - 10	2220	100	2 piece	220x107x100	MN2-14	8940168574
				3 piece	220x165x100	MN3-14	8940168575
1/2" G	17 / 0 - 10	3000	200	2 piece	255x150x125	MD2-12	8940168576
				3 piece	255x232x125	MD3-12	8940168577

operating temperatures -20°C\* – 65°C (\*\*-34°C\* – 80°C)  
 \* air supply must be dry enough to avoid ice formation at temperatures below 2 °C

### spray painting unit (0,01 micron)

Delivers extremely clean and oil-free, dry air at constant pressure for spray guns and other oil-free running air tools : water separator with automatic drain, filter element with 5 micron, high efficiency oil and particle removal filter element with 0,01 micron (oil removal class level 2 – 0,01 mg/m³) and filter service indicator shows red when filter needs replacement, air distribution block with 2 outlets and air valves, metal bowls with bajonet quick release and prismatic full level sight windows for high inlet pressure and increased safety, fast element clamping system allows front access and individual removal of elements, wall fixation bracket water separator – filter – regulator and gauge + coalescing filter + distribution block + air valves

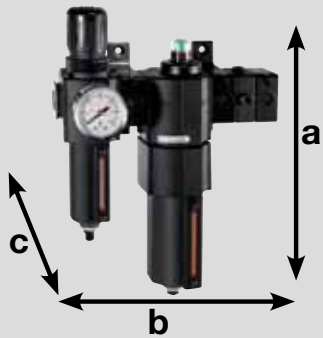

thread (inch)	pressure (IN / OUT) (bar)	max. air flow rate (l/min)	oil capacity (ml)	dimension axbxc (mm)	model	article no.
1/2" IG	17 / 0 - 10	3000	200	174 - 160	MD2LAK-12	8940168482

operating temperatures -20°C\* – 65°C \* air supply must be dry enough to avoid ice formation at temperatures below 2 °C

### power regulator ° (reduces power and speed).



characteristics (in-out)	model	article no.
1/4" IG – 1/4" AG	AR 1	8951011858
1/4" IG – 1/4" AG	DG 1 R	8951011860

### inline lubricator ° (for mobile use e.g. on construction sites)



characteristics (in-out)	model	article no.
1/4" IG - 1/4" AG (4 ml*)	G 1 K	8951011851
1/4" IG - 1/4" IG (28 ml*)	G 1 G	8951011852**
3/8" IG - 3/8" IG (28 ml*)	G 2	8951011853**
1/2" AG - 1/2" AG (28 ml*)	G 3	8951011854**
1/4" IG - 1/4" AG (12 ml*)	G 1 M	8951011856

\* oil capacity \*\* adjustable

### swivel air joint ° (for best operatability in confined areas)



1/4" IG – 1/4" AG	DG 1	8951011859
1/4" IG – 1/4" AG	DG 1 R	8951011860

° for connection into tool air inlet IG: female thread  
 AG: male thread

### inline filtre °



1/4" FT – 1/4" AG	F 1 G	8951011855
-------------------	-------	------------

### Lubricants for air tools



special air lubricant (contains silicone)

impact system oil (for pin-clutch type)

model	article no.
1000 L, 1 litre air lubrication oil in bottle with nozzle	8951011861
1000 S, 1 litre impact system oil in bottle with nozzle	8951011862

# Couplings and Plugs, Fittings

## Safety Series 7.2 mm

(EURO-profile)

dimension	coupling with thread	article no. / model
1/4" AG		8951011740 / SK 701
3/8" AG		8951011741 / SK 702
1/2" AG		8951011742 / SK 703
1/4" IG		8951011743 / SK 704
3/8" IG		8951011744 / SK 705
1/2" IG		8951011745 / SK 706
inner hose diameter	coupling for hoses	article no. / model
Ø 6 .. 7 mm		8951011746 / SK 707
Ø 8 mm		8951011747 / SK 708
Ø 9 .. 10 mm		8951011748 / SK 709
Ø 13 mm		8951011750 / SK 713
dimension	diverter with couplings	article no. / model
1/4" IG		8951011762 / SK 760
3/8" IG		8951011763 / SK 761
1/2" IG		8951011764 / SK 762
plug with thread	dimension	article no. / model
	1/4" AG	8951011756 / SK 728
	3/8" AG	8951011757 / SK 729
	1/2" AG	8951011758 / SK 730
	1/4" IG	8951011759 / SK 731
	3/8" IG	8951011760 / SK 732
	inner hose diameter	article no. / model
	Ø 6 .. 7 mm	8951011751 / SK 716
	Ø 8 mm	8951011752 / SK 718
	Ø 9 mm	8951011753 / SK 719
	Ø 10 mm	8951011754 / SK 720
Ø 13 mm	8951011755 / SK 723	

flow direction →

## Brass Series 7.2 mm

(EURO-profile)

dimension	coupling with thread	article no. / model
BSP 1/4" AG		8951011784
BSP 3/8" AG		8951011785
BSP 1/2" AG		8951011786
BSP 1/4" IG		8951011787
BSP 3/8" IG		8951011788
BSP 1/2" IG		8951011789
inner hose diameter	coupling for hoses	article no. / model
Ø 6 .. 7 mm		8951011790
Ø 9 .. 10 mm		8951011791
Ø 13 mm		8951011792
dimension	diverter with couplings	article no. / model
3/8" IG 2-Weg		8951011819
3/8" IG 3-Weg		8951011820
plug with thread	dimension	article no. / model
	BSP 1/4" AG	8951011808
	BSP 1/4" AG	8951011809
	BSP 3/8" AG	8951011810
	BSP 1/2" AG	8951011811
	BSP 1/4" IG	8951011812
	BSP 3/8" IG	8951011813
	inner hose diameter	article no. / model
	Ø 6 .. 7 mm	8951011795
	Ø 9 mm	8951011796
	Ø 13 mm	8951011797

flow direction →

## claw couplings

(very high flow rate)

coupling with thread	dimension	article no. / model
	1/2" AG	KKG1/2 / 8951011816
	3/4" AG	KKG3/4 / 8951011817
coupling for hoses	inner hose diameter	article no. / model
	Ø 19 mm	KKS19 / 8951011818

RODCRAFT claw coupling fit each other

## Patented Composite - Safety Couplings

(EURONORM and ISO safety standard)

- robust design with low weight
- safety system (2 movements with pressure release)
- very high flow rate (even at 6,3 bar using 7,2 mm diameter series approx. 1700 l/min)
- new technology: extremely air proof, low force coupling, reduced danger to scratch paint due to composite elements, industrial gasket system with nitrile O-rings
- excellent material quality: shock resistant, low wear, squeeze-proof design
- 10 time higher life time than standard couplings
- galvanised steel thread fittings, male threads ready to seal with teflon coating
- plug made of steel with anti-stain coating, male threads ready to seal with teflon coating
- Several plug-coupling profiles available EURO/DIN 7.2 mm - 7.4 mm, SO 6150 B, MIL 409 C (6 mm) and 8 mm high-flow format
- with check valve

## Safety System

### First step:

the valve stops the air flow, pressure is released from plug side of the air line i.e. no danger of lashing out hose tails (pull)"

### Second step:

complete separation of the connection without pressure (press) i.e. no danger

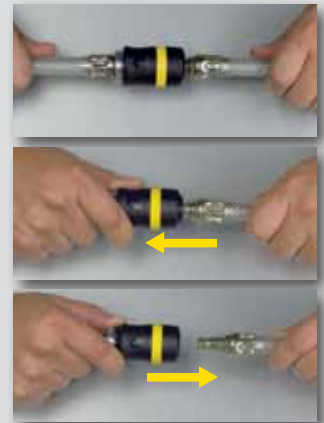

## Brass Standard Couplings

Solid version with high flow rate for daily use  
With check valve



## Brass Claw Couplings

For very high flow rates (use valve upstream for safety, does not contain a check valve)  
typical for air connections to construction site compressors.

## Further connecting accessory

dimension	hose stems	inner hose diameter	article no. / model
BSP 1/4" AG		6 mm	8951011801
BSP 1/4" AG		9 mm	8951011802
BSP 3/8" AG		9 mm	8951011803
BSP 3/8" AG		13 mm	8951011804
BSP 1/2" AG		13 mm	8951011805
BSP 1/2" AG		9 mm	8951011806
inner hose diameter	hose connectors	inner hose diameter	article no. / model
6 mm Ø		6 mm Ø	8951011798
9 mm Ø		9 mm Ø	8951011799
13 mm Ø		3 mm Ø	8951011800

dimension	threaded connectors/reducers	dimension	article no. / model
1/4" AG		1/4" AG	8951011822
3/8" AG		1/4" AG	8951011824
3/8" AG		3/8" AG	8951011821
1/2" AG		3/8" AG	8951011825
1/2" AG		1/2" AG	8951011827
3/8" AG		1/4" IG	8951011823
1/2" AG		3/8" IG	8951011828
1/2" AG		1/4" IG	8951011839

female thread

More profiles available on request  
IG: female thread  
AG: male thread

All indicated articles with thread type BSP (GAS)  
NPT - threads available on request!

## Compressed Air Hoses



360°

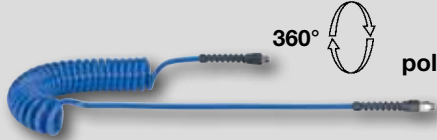

360°



material	diameter (internal x external)	work length	end fittings	article no.
polyethylene PE	8 x 10 mm	5 m	Euro coupling/plug profile	8951011831
		8 m	Euro coupling/plug profile	8951011833
		10 m	Euro coupling/plug profile	8951011835
polyurethane PUR	8 x 12 mm	6 m	1/4" AG	8951011845*
		4 m	Euro coupling/plug profile 3/8" AG	8951011842* 8951011847*
Polyvinylchlorid PVC	9 x 15 mm 13 x 21 mm	6 m	Euro coupling/plug profile 3/8" AG	8951011843* 8951011846* 8951011844* 8951011848*
		8 m	Euro coupling/plug profile 3/8" AG	8951011844* 8951011848*
		50 m		8951011836 8951011837

The hoses are equipped with swivelling end fittings (polyethylene and polyurethane).  
\* small spiral diameter - less knots / less hose damages AG = male thread

## Hose Reels

### SAR 12 with steel body

### SAR 14 with composite body

hose length	12 m		13.5 m	
fittings	1/4" AG		1/4" AG	
hose diameter (internal x external)	8 x 12 mm		9.5 x 13 mm	
operating pressure	max. 15 bar		max. 17 bar	
weight	8 kg		8.3 kg	
article no.	8951011840		8951011841	

AG = male thread



## Silencing exhaust hose systems (DUS)





Model	hose assembly	Model	hose assembly	Model	hose assembly	Model	hose assembly	Model	hose assembly	Model	hose assembly
RC2177	DUS 35 8955000015	RC2373Xi	DUS 32 8951011885	RC3607	DUS 21*, <sup>3m)</sup> 8951011867	RC6040RE	DUS34 8951011887	RC7015RE	DUS 22 8951011868	RC7060RE	DUS 23 8951011869
RC2205RE	DUS 20 8951011866	RC2403Xi	DUS 32 8951011885	RC3600RE	DUS 21*, <sup>3m)</sup> 8951011867	RC6060RE	DUS 28 8951011874	RC7020	DUS 21*, <sup>3m)</sup> 8951011867	RC7065RE	DUS 23 8951011869
RC2206RE	DUS 20 8951011866	RC2425	DUS 26* 8951011872	RC3630RE	DUS 21*, <sup>3m)</sup> 8951011867	RC6067	DUS 31* 8951011884	RC7021	DUS 21*, <sup>3m)</sup> 8951011867	RC7075RE	DUS 21 <sup>3m)</sup> 8951011867
RC2227	DUS 36 8955000027	RC2426	DUS 26* 8951011872	RC4400	DUS 23* 8951011869	RC6068RE	DUS 31 <sup>1.5)</sup> 8951011884	RC7025RE	DUS 23 8951011869	RC7077RE	DUS 21 <sup>3m)</sup> 8951011867
RC2257	DUS 36 8955000027	RC2433Xi	DUS 26* 8951011872	RC4500	DUS 23* 8951011869	RC6210	DUS 21*, <sup>3m)</sup> 8951011867	RC7026RE	DUS 23 8951011869	RC7078RE	DUS 21 <sup>3m)</sup> 8951011867
RC2263TL	DUS 19* 8951011865	RC3000	DUS 21*, <sup>3m)</sup> 8951011867	RC4550	DUS 23* 8951011869	RC6212	DUS 21*, <sup>3m)</sup> 8951011867	RC7027	DUS 21*, <sup>3m)</sup> 8951011867	RC7079RE	DUS 21 <sup>3m)</sup> 8951011867
RC2263Xi	DUS 19* 8951011865	RC3005	DUS 21*, <sup>3m)</sup> 8951011867	RC4600	DUS 21*, <sup>3m)</sup> 8951011867	RC6605RE	DUS 29 8951011875	RC7035	DUS 21*, <sup>3m)</sup> 8951011867	RC7100RE	DUS 24 8951011870
RC2267	DUS 35 8955000015	RC3010	DUS 21*, <sup>3m)</sup> 8951011867	RC4607	DUS 21*, <sup>3m)</sup> 8951011867	RC6606RE	DUS 29 8951011875	RC7037	DUS 21*, <sup>3m)</sup> 8951011867	RC7107	DUS 23 8951011869
RC2277	DUS 35 8955000015	RC3015	DUS 21*, <sup>3m)</sup> 8951011867	RC4650	DUS 21*, <sup>3m)</sup> 8951011867	RC6610	DUS 25* 8951011871	RC7040	DUS 21*, <sup>3m)</sup> 8951011867	RC7681K	DUS 35 8955000015
RC2305RE	DUS 20 8951011866	RC3060	DUS 25* 8951011871	RC4700	DUS 23* 8951011869	RC7010	DUS 24 8951011870	RC7045	DUS 24* 8951011870	RC7682K	DUS 35 8955000015
RC2363Xi	DUS 32 8951011885	RC3260	DUS 25* 8951011871	RC4760	DUS 23* 8951011869	RC7011	DUS 23 8951011869	RC7050RE	DUS 30 8951011876	RC7683K	DUS 35 8955000015

RE = system included with delivery of the tool  
<sup>1.5)</sup> especially long hose system (1,5m) model DUS 31  
 ET see spare parts list of tool

\* = system available as extra accessory  
<sup>3m)</sup> 3 m long exhaust hose system available as extra accessory model DUS 27

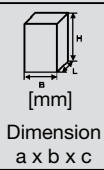
# Mini Grease Pumps

## grease and mini grease pumps

special heavy duty grease for DUOPACT, SH, DH and CH impact systems		
model	article no.	
8150 F, grease pump, filled	8951012205	168x34
		
8150 grease pump, incl. 2 cartridges	8951012204	168x34
		
8150 K, 5 cartridges, filled	8951012206	
8160 mini grease pump	8951012208	115x75x35
		

model	article	page	LWA [dB(A)]	k [m/s <sup>2</sup> ]	model	article	page	LWA [dB(A)]	k [m/s <sup>2</sup> ]	model	article	page	LWA [dB(A)]	k [m/s <sup>2</sup> ]	model	article	page	LWA [dB(A)]	k [m/s <sup>2</sup> ]	
RC2100	8951077010	5	108	0.9	RC5550	8951076018	22	98.5	2.1	RC7183	8951075091	40	101							
RC2111	8951077020	5	104	0.9	RC5551	8951076019	22	105	2.7	RC7190	8951075101	40	101							
RC2177	8951000043	5	101	2.5	RC5605	8951076000	21	/		RC7200V	8951072111	46	97.2	1.3						
RC2205	8951077060	6	98.4	1.2	RC5610	8951076001	22/23	101	2.2	RC7451V	8951072102	48	88.5	2.2						
RC2205RE	8951077350	6	98.4	1.2	RC5615	8951076002	23	99.1	1.6	RC7500	8951072101	48	91.1	2.6						
RC2227	8951000036	6	105	1.7	RC5620	8951076003	23	109	1.9	RC7661V	8951072231	44	98.0							
RC2257	8951000037	6	104	2.3	RC5625	8951076004	23	105	3	RC7681K	8951000019	38/39	85.6							
RC2263TL	8951077007	7	104	1.6	RC5630	8951076005	23	111	3.3	RC7682K	8951000018	44	90.6							
RC2263Xi	8951077420	7	105	1.5	RC5900	8951076006	24	92.3		RC7683K	8951000017	42	89.5							
RC2267	8951000044	6	104	2.0	RC5940	8951076007	24	96.9		RC7691V	8951072212	46	98.6							
RC2277	8951000025	7	104	2.6	RC6040RE	8951079041	26	85		RC7700V	8951072181	48	91.6	1						
RC2305RE	8951077440	8	103	1.4	RC6050	8951079001	26	90.9	2.09	RC7702V6	8951000021	45	90.5	1.5						
RC2315	8951077130	8	102	1.5	RC6051	8951179000	26	90.9	2.09	RC7705V6	8951000020	45	97.1	1.2						
RC2345	8951077150	8	106	1.1	RC6067	8951079011	26	90.9	1.36	RC7805V6-2H	8951000022	46	94.0	1.64						
RC2350	8951077160	8	103	1.3	RC6068	8951179020	26	90.9	1.36	RC7710V6	8951000070	45	90.1	2.3						
RC2363Xi	8951077520	8	105	3.6	RC6100	8951076008	25	103		RC7810V6-2H	8951000023	46	94.0	1.64						
RC2373Xi	8951077532	8	105	3.4	RC6210	8951076009	25	98.2		RC7802RV1	8951072022	48	91.5	1.2						
RC2403Xi	8951077550	9	106	3.7	RC6212	8951076020	25	98.2		RC7905	8951000016	47								
RC2425	8951077190	9	109	2.0	RC6220	8951076010	24	76.2		RC7910	8951089014	47								
RC2426	8951077032	9	107	1.8	RC6301	8951076011	27	81.6		RC8000	8951070000	51								
RC2433Xi	8951077500	9	108	2.0	RC6450	8951076012	27	89.6		RC8006	8951070010	51								
RC2439	8951077200	9	110	1.6	RC6451	8951176000	27	89.6		RC8007	8951070020	51								
RC2444	8951077210	11	115	1.4	RC6453	8951076013	27	99.8		RC8010	8951070030	52								
RC2449	8951077042	9	110	1.5	RC6605RE	8951074005	30	90.8		RC8011	8951070040	52								
RC2466	8951000047	10	111	1.6	RC6606RE	8951174000	30	90.8		RC8035	8951070050	52								
RC2476	8951000048	10	111	1.9	RC6610	8951074000	30	97.9		RC8102/14	8951070002	50								
RC2477Xi	8951000046	10	117	3.86	RC6700	8951074001	28	97.5	0.8	RC8103/08	8951070012	50								
RC2484Xi	8951077132	10	106	1.9	RC6703Xi	8951074007	28	82	0.7	RC8106/13	8951070011	50								
RC2485	8951077240	11	110	2.0	RC6710	8951074002	28	75.1	0.9	RC8107/14	8951070021	52								
RC2490	8951077250	11	109	1.9	RC6715	8951074003	28	87.3	0.7	RC8112	8951070003	49								
RC2530	8951077260	11	108	1.9	RC6718Xi	8951074008	28	87.2	0.7	RC8113	8951070023	49								
RC2585	8951077270	11	107	2.0	RC6720	8951074004	29	77.2	0.8	RC8115	8951070034	52								
RC3000	8951078012	14	92.7		RC6900	8951075000	25	95.5		RC8116	8951070004	52								
RC3001	8951078022	14	103		RC7010	8951075040	32	93.4	0.9	RC8118	8951011018	52								
RC3005	8951078042	15	96.5		RC7011	8951075050	32	93.7	1.8	RC8120	8951070014	53								
RC3010	8951078013	15	95.2		RC7012	8951175000	32	93.7	1.8	RC8125	8951070024	53								
RC3015	8951078052	14	93.4		RC7015RE	8951075111	38	96.8	2.2	RC8135	8951070070	54								
RC3060	8951078062	14	100		RC7016RE	8951175011	38	96.8	2.2	RC8141	8951070090	54								
RC3100	8951078004	16	104		RC7020	8951075080	33	94.4		RC8150	8951012204	68	/							
RC3200	8951078023	15	102		RC7021	8951175010	33	94.4		RC8150F	8951012205	68	/							
RC3260	8951078033	15	103		RC7025RE	8951075130	33	88.9	0.8	RC8150K	8951012206	68	/							
RC3600	8951078034	16	96.4		RC7027	8951075330	33	94.4		RC8160	8951012208	68								
RC3600RE	8951078104	16	96.4		RC7026RE	8951075150	33	88.9	0.8	RC8240	8955000026	53								
RC3601RE	8951178014	16	96.4		RC7035	8951075100	34	93.4		RC8240S	8955000009	53								
RC3607	8951078114	16	99.2		RC7037	8951075340	34	93.4		RC8241	8955000010	53								
RC3630	8951078054	15	96.9		RC7040	8951075110	34	90.9		RC8241S	8955000011	53								
RC3700	8951078074	16	103		RC7045	8951075120	32	94.9	0.8	RC8500	8951011022	53								
RC4100	8951073000	17	97.7	1.7	RC7050RE	8951075190	32	86.2	0.8	RC8501	8951011023	53								
RC4105	8951073001	17	82.3	1.7	RC7060RE	8951075210	33	84.7	0.8	RC8502	8951011024	53								
RC4107	8951073011	17	92.3	1.7	RC7065RE	8951075230	33	84.7	0.9	RC8503	8951011025	53								
RC4300	8951073020	18	98	1.7	RC7072RE	8951075270	34	85.8		RC8504	8951011026	53								
RC4400	8951073030	18	93.3	1.7	RC7075RE	8951075290	34	85.1		RC8505	8951011027	53								
RC4500	8951073021	17	104	1.7	RC7077RE	8951075310	34	85		RC9026	8951077560	12	98.9							
RC4550	8951073031	18	103	1.7	RC7078RE	8951075320	34	84.5		AGS185	8951089055	30	/							
RC4600	8951073040	17	92.3	1.7	RC7079RE	8951074009	34	84.5		RF02G	8951011019	12								
RC4607	8951073090	17	92.3		RC7080	8951075160	33	95.9	0.7	RFP04G	8951012306	12								
RC4650	8951073050	17	101	1.7	RC7091	8951176010	36			RFP03DG	8951011020	12								
RC4700	8951073002	19	99.6		RC7100RE	8951075121	38	98.3	1.1	STS70K	8951011086	30	/							
RC4760	8951073012	19	99.7		RC7107	8951075005	38	93	1.3	STS71K	8951011087	30	/							
RC4780	8951073003	19	101		RC7108	8951175005	38	93	1.3											
RC4784	8951073023	19	91.3		RC7120	8951072001	39	102	0.8											
RC5030	8951071010	22	80.8	0.9	RC7121	8951072011	39	92	0.8											
RC5100	8951071022	20	106	1.9	RC7130	8951072004	42	98.9	1.2											
RC5120	8951171013	20	106	1.9	RC7131	8951072014	42	91.8	0.8											
RC5150	8951171023	20	106	1.9	RC7150	8951072021	39	92	0.8											
RC5160	8951171033	20	106	1.9	RC7155	8951072041	35	90.5	0.7											
RC5170	8951071032	21	111	0.9	RC7156	8951072051	35	94.2	0.7											
RC5175	8951071042	21	108	0.9	RC7157	8951072061	35	103	0.9											
RC5176	8951171043	21	108	0.9	RC7160	8951075021	40	96.2												
RC5180	8951071052	20	111	0.9	RC7165	8951075041	40	94.8												
RC5305	8951071065	21	108	2.2	RC7166	8951075051	40	96.6												
RC5310	8951171053	21	108	2.2	RC7180	8951075071	40	102												
RC5400	8951071076	21	110	1.9	RC7181	8951075081	40	101												

# Sales and Service in Europe

## RODCRAFT in Central Europe

### Sales Company

### Service



Germany

#### RODCRAFT Central Europe

Langemarckstraße 35  
45141 Essen  
Germany  
phone: +49 (0)201 21 77 781  
fax: +49 (0)201 21 77 784  
email: info@rodcraft.com

#### Rodcraft Service Center

W. Valentin GmbH & Co. KG  
Gewerbeschulstraße 99 – 103  
42289 Wuppertal  
Germany  
phone: +49 (0)202 25 59 8-0  
fax: +49 (0)202 25 59 8-19  
email: info@valentin-service.de



Austria

#### RODCRAFT Central Europe

Langemarckstraße 35  
45141 Essen  
Germany  
phone: +49 (0)201 21 77 781  
fax: +49 (0)201 21 77 784  
email: info@rodcraft.com

#### Rodcraft Service Center

Pixner GmbH & Co KG  
Robingstr. 9a  
A-5020 Salzburg  
Austria  
phone: (0662) 88920-0  
fax: (0662) 88920-28  
email: info@rodcraft.com



Switzerland

#### RODCRAFT Central Europe

Langemarckstraße 35  
45141 Essen  
Germany  
phone: +49 (0)201 21 77 781  
fax: +49 (0)201 21 77 784  
email: info@rodcraft.com

#### Rodcraft Service Center

Intool AG  
Hinterbergstrasse 30  
CH- 6330 Cham  
Swiss  
phone: +41 (0)41 748 07 00  
fax: +41 (0)41 748 07 01  
email: mail@intool.ch



Belgium

#### RODCRAFT Central Europe

Langemarckstraße 35  
45141 Essen  
Germany  
phone: 0 800 791 27  
fax: 0 800 763 75  
email: info@rodcraft.com

#### RODCRAFT Service Center

Industrielaan 44  
BE-3730 Hoeselt  
Belgium  
phone: 0 800 791 28\*  
fax: 0 800 791 33\*  
email: info@rodcraft.com



Netherlands

#### RODCRAFT Central Europe

Langemarckstraße 35  
45141 Essen  
Germany  
phone: 0 800 02 21 610  
fax: 0 800 02 21 709  
email: info@rodcraft.com

#### RODCRAFT Service Center

Industrielaan 44  
BE-3730 Hoeselt  
Belgium  
phone: 0800 02 21 571\*\*  
fax: 0800 02 21 724\*\*  
email: info@rodcraft.com



Luxembourg

#### RODCRAFT Central Europe

Langemarckstraße 35  
45141 Essen  
Germany  
phone: +49 (0)208 21 77 729  
fax: +49 (0)208 21 77 792  
email: info@rodcraft.com

#### RODCRAFT Service Center

Industrielaan 44  
BE-3730 Hoeselt  
Belgium  
phone: +32 89 51 07 86  
fax: +32 89 51 07 89  
email: info@rodcraft.com

## RODCRAFT in South West Europe



France

#### RODCRAFT France

38 rue Bobby Sands, ZAC de la Lorie BP10273  
44818 SAINT HERBLAIN CEDEX  
France  
phone: +33 (0)240 808 909  
fax: +33 (0)240 80 20 19  
email: info.france@rodcraft.com

#### RODCRAFT Service Après Vente ARM

57, route de Bray  
77130 Marolles-sur-Seine  
France  
phone: 01 64 31 24 36  
fax: 01 60 96 76 06  
email: infosarm@armrepar.fr



Italy

#### RODCRAFT Italy

Viale della Repubblica, 65  
20851 Lissone (Milano)  
Italy  
phone: +39-039 244 101  
fax: +39-039 465 50 25

#### RODCRAFT Servizio Clienti

Homberger SPA  
Via Ippolito d'aste, 1/1  
16121 Genova (GE)  
Italy  
phone: +39-0 10 5 76 52 70  
fax: +39-0 10 5 76 53 35  
email: officina@homberger.com



Spain

#### RODCRAFT Spain

Avenida Industria, 9, Polígono Industrial Alcobendas  
28100 Alcobendas  
Spain  
phone: +34 91 590 31 52  
fax: +34 91 590 31 61



Portugal

#### RODCRAFT Portugal

Avenida Industria, 9, Polígono Industrial Alcobendas  
28100 Alcobendas  
Spain  
phone: +34 91 590 31 52  
fax: +34 91 590 31 61

## RODCRAFT in Eastern Europe

**Albania, Bosnia, Herzegovina, Bulgaria, Croatia, Hungaria, Macedonia, Montenegro, Romania, Serbia, Slovakia, Slovenia**

**RODCRAFT Eastern Europe**  
Chemická 4  
831 04 Bratislava  
Slovakia  
phone: +421 264 462 636  
fax: +421 264 463 464  
email: info.slovakia@rodcraft.com

**Poland**  
phone: +48 22 720 96 10  
fax: +48 22 720 96 15  
email: info.poland@rodcraft.com

**Czechia**  
phone: +420 225 434 152  
fax: +420 225 434 131  
email: info.czech@rodcraft.com

## RODCRAFT in the UK and Ireland

**United Kingdom, Ireland**

**RODCRAFT UK**  
37 Mark Road, Hemel Hempstead  
Herts  
United Kingdom  
phone: +44 (0)1442 838 999  
fax: +44 (0)1442 838 989  
email: rc.ukinfo@rodcraft.com

## RODCRAFT in Nordic

**Denmark, Finland, Iceland, Norway, Sweden, Estonia, Lithuania, Latvia**

**RODCRAFT Nordic**  
Kville 18  
SE-450 Fjällbacka  
Sweden  
phone: +46 (0) 525 352 55  
fax: +46 (0) 525 350 93

## RODCRAFT in Russia

**Belarus, Russia, Ukraine**

**RODCRAFT Russia**  
15, Vashutinskoe road  
Khimki, Moscow region  
141402  
Russia  
phone: +7 495 933 5553  
fax: +7 495 933 5557

## RODCRAFT in the Middle East

**Middle East**

**RODCRAFT Middle East**  
P.O. Box 122778, Plot 368/471, Warehouse No. 2,  
Hasa Road, Street 8, Al Quoz Industrial Area 3  
Dubai  
United Arab Emirates  
phone: +9714 7040271  
+971 50 6610828  
fax: +9714 7040294

## RODCRAFT in India

**India**

**RODCRAFT India**  
2nd Floor, RUSHABH, Near American Heart Institute  
Ghodbunder Rd  
Manpada, THANE (West) - 400607  
India  
phone: +91 22 39 98 27 31  
+91 98 33 48 91 64  
fax: +91 22 39 98 27 25

## RODCRAFT in South Africa

**South Africa**

**RODCRAFT South Africa**  
Hughes Business Park,  
Saligna Street, Witfield, Gauteng,  
1459  
South Africa  
phone: +27(0) 11 437 6932  
+27(0) 11 437 6933  
fax: +27(0) 11 388 1672

A broad range of products for garages, industry and craftsmen



Air tools and accessory



Workshop cranes, hydr. presses, jacks, oil service tools etc.



For fast information, news, downloads of product information, spare part information, manuals.



# Impact Wrenches

Drills

Screwdrivers

Ratchets

Orbital Sanders

# Saws

Blow Guns

# Riveters

Paint Guns

Angle Grinders

Die Grinders

# Accessory

Auto Glass Removal Tools



**Your Dealer:**